

Hand lever valve (5/2 way, 5/3 way)

4H Series

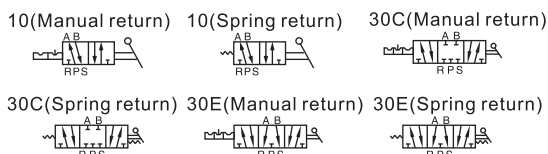

Symbol



Product feature

1. Manual operation, smooth actuation, and exact and reliable orientation.
2. Sliding column structure has good tightness and light weight and is easy to install and dismount.
3. Internal hole adopts special processing technology which has little attrition friction, long service life.
4. No need to add oil for lubrication.
5. Panel-mounting makes it convenient to install and apply.

Flow chart

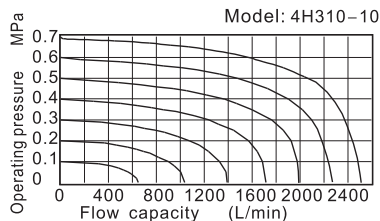
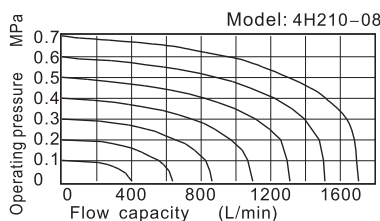

Inner structure

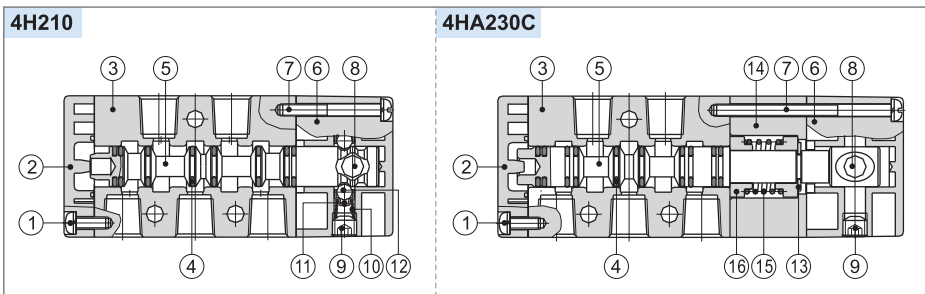

No.	Item	No.	Item
1	Round head screw	9	Stop screw
2	Bottom cover	10	Spring
3	Body	11	Steel ball jacket
4	O-ring	12	Steel ball
5	Spool	13	E clip
6	Top cover	14	Side cover
7	Round head cover	15	Spring
8	Axle	16	Spring holder

Installation

1. 5/3 way manual return hand lever valve is positioned by steel ball, which is convenient to switch. Please apply the proper force to avoid the position mismatch and misoperation.
2. When installed by panel, disassemble the gasket according to the practical requirement.
3. Below is the installation method for reference.
Note: Please give your attention on the panel thickness and hole dimension when installed by panel.

200 Series: $\leq 5\text{mm}$
300 Series: $\leq 6\text{mm}$
Panel thickness

200 Series: $\Phi 16$
300 Series: $\Phi 20$
Dia. of installation hole

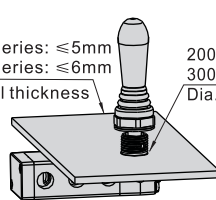

Panel Installation

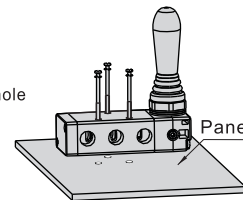

Body Installation

Specification

Model	210-06	230-06	210-08	230-08	310-08	330-08	310-10	330-10
Fluid	Air (to be filtered by 40 μm filter element)							
Operating	Manual control direct acting type							
Port size[Note1]	In=Out =Exhaust=1/8"		In=Out=1/4"; Exhaust=1/8"		In=Out =Exhaust=1/4"		In=Out=3/8"; Exhaust=1/4"	
Orifice size	14.0mm ² (Cv=0.78)	12.0mm ² (Cv=0.67)	16.0mm ² (Cv=0.89)	12.0mm ² (Cv=0.67)	25.0mm ² (Cv=1.39)	18.0mm ² (Cv=1.00)	30.0mm ² (Cv=1.67)	18.0mm ² (Cv=1.00)
Valve type	5/2 way	5/3 way	5/2 way	5/3 way	5/2 way	5/3 way	5/2 way	5/3 way
Lubrication [Note2]	Not required							
Pressure range	0~1.0MPa(0~145psi)							
Proof pressure	1.5MPa(215psi)							
Temperature	-20~70°C							
Material body	Aluminum alloy							
Operating angle	$\pm 15^\circ$	$\pm 8.5^\circ$	$\pm 15^\circ$	$\pm 8.5^\circ$	$\pm 18^\circ$	$\pm 10^\circ$	$\pm 18^\circ$	$\pm 10^\circ$

[Note1] G thread is available.

[Note2] Once lubricated air is used, continue with same medium to optimise valve life span. It is suggested to use ISO VG32 lubricant or the oil with the same grade.

Ordering code

4H 2 30C 08 G

① ② ③ ④ ⑤

① Model	② Code	③ Valve type	④ Port size	⑤ Thread type
4H: Manual return 4HA: Spring return	2: 200 Series 3: 300 Series	10: 5/2 Way 30C: 5/3 Way closed center 30E: 5/3 Way exhaust center	06: 1/8" 08: 1/4" 08: 1/4" 10: 3/8"	G: G



Hand lever valve (5/2 way, 5/3 way)

4H Series

Dimensions

4H210\310, 4HA210\310

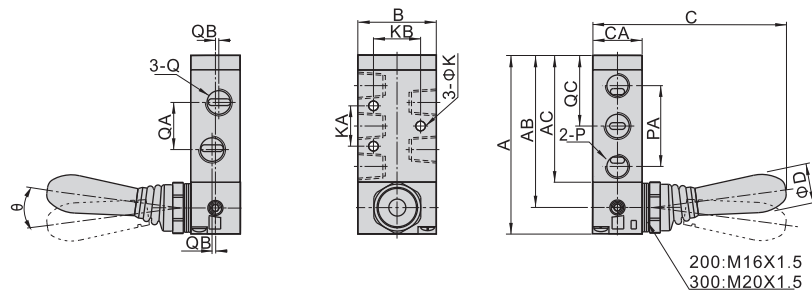

Model\Item	A	AB	AC	B	C	CA	D	K	KA	KB	P	PA	Q	QA	QB	QC	Θ
4H210-06 4HA210-06	81.5	69.5	57.5	35	90	22	18	4.3	20	23.5	1/8"	36	1/8"	18	-	32.5	15
4H210-08 4HA210-08	81.5	69.5	57.5	35	90	22	18	4.3	20	23.5	1/8"	36	1/4"	21	1.5	32.5	15
4H310-08 4HA310-08	101	87	73	40	93.5	27	18	4.3	24	27.5	1/4"	45	1/4"	22	-	40.5	18
4H310-10 4HA310-10	101	87	73	40	93.5	27	18	4.3	24	27.5	1/4"	45	3/8"	24	2	40.5	18

4H230, 4H330

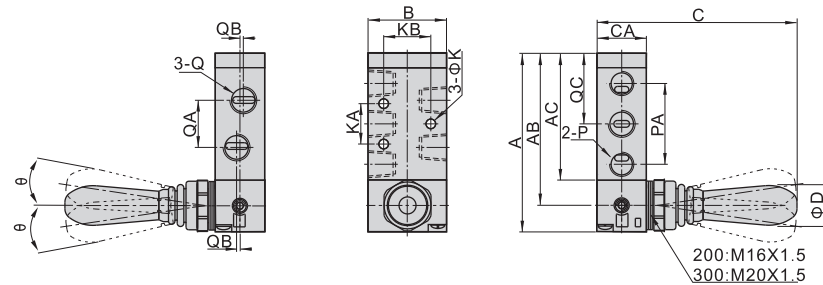

Model\Item	A	AB	AC	B	C	CA	D	K	KA	KB	P	PA	Q	QA	QB	QC	Θ
4H230C-06 4H230E-06	81.5	69.5	57.5	35	90.5	22	18	4.3	20	23.5	1/8"	36	1/8"	18	-	32.5	8.5
4H230C-08 4H230E-08	81.5	69.5	57.5	35	90.5	22	18	4.3	20	23.5	1/8"	36	1/4"	21	1.5	32.5	8.5
4H330C-08 4H330E-08	101	87	73	40	94	27	18	4.3	24	27.5	1/4"	45	1/4"	22	-	40.5	10
4H330C-10 4H330E-10	101	87	73	40	94	27	18	4.3	24	27.5	1/4"	45	3/8"	24	2	40.5	10

4HA230, 4HA330

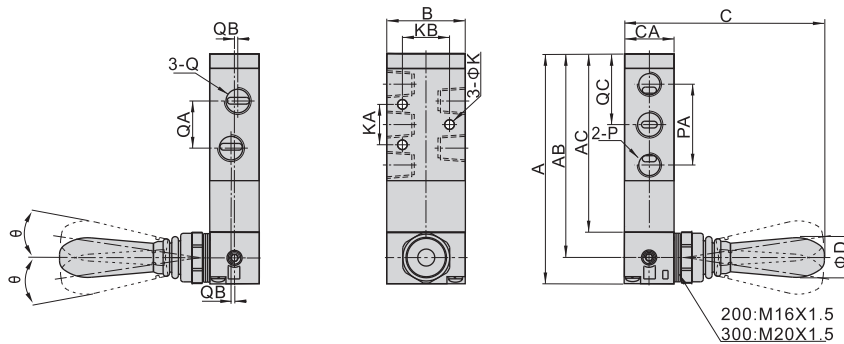

Model\Item	A	AB	AC	B	C	CA	D	K	KA	KB	P	PA	Q	QA	QB	QC	Θ
4HA230C-06 4HA230E-06	100.5	88.5	76.5	35	90.5	22	18	4.3	20	23.5	1/8"	36	1/8"	18	-	32.5	8.5
4HA230C-08 4HA230E-08	100.5	88.5	76.5	35	90.5	22	18	4.3	20	23.5	1/8"	36	1/4"	21	1.5	32.5	8.5
4HA330C-08 4HA330E-08	120	106	92	40	94	27	18	4.3	24	27.5	1/4"	45	1/4"	22	-	40.5	10
4HA330C-10 4HA330E-10	120	106	92	40	94	27	18	4.3	24	27.5	1/4"	45	3/8"	24	2	40.5	10