

Micro-solenoid valve(3/2 way)

CPV15 Series

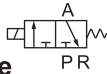

Symbol



Product feature

1. None polarity design of DC circuit, the direction(vertical or horizontal) of wiring can be adjusted freely according to the installation demand.
2. Low starting voltage and long service life.
3. There is no buzzing by the usage of AC power supply .
4. With surge device can avoid the damage of solenoid valve by surge voltage.

Flow chart

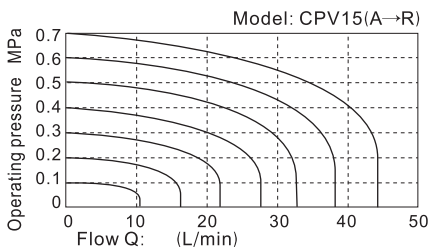
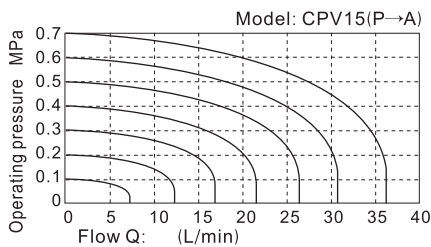

Dimensions

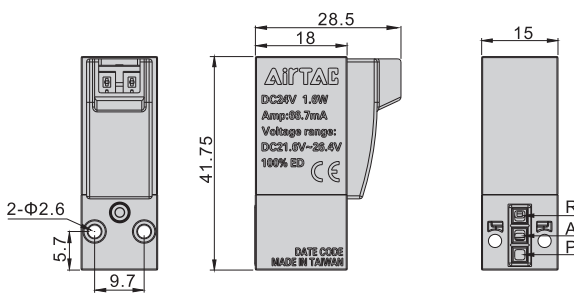

Specification

Model	CPV15				
Fluid	Air(to be filtered by 40 μ m filter element)				
Acting	Direct acting				
Orifice size	Φ0.8mm				
Valid area or section	0.44mm ² (Cv=0.024); 0.55mm ² (Cv=0.03)				
Valve type	3 port 2 position				
Weight	micro-solenoid valve	33.2g			
	Wire	050: 4.6g	200: 21.4g		
	Screw(2pcs)	1.45g			
Operating pressure	0.15~0.8MPa(21~114psi)				
Proof pressure	1.5MPa(215psi)				
Temperature	-20~70℃				
Standard voltage	AC220V	AC110V	AC24V	DC24V	DC12V
Scope of voltage	DC ± 10%; AC+15% ~ -10%				
Protection	Dustproof				
Temperature classification	F Class				
Power consumption	DC: 1.6W; AC: 2.0VA				
Electrical entry	Terminal				
Activating time	on<10ms; off<10ms				

Ordering code

Ordering code of valve's body

CPV 15 B P-050



① Model	② Width of body	③ Voltage	④ Code of manual override	⑤ Wire length [Note1]
CPV: CPV series micro-solenoid valve	15: 15mm	A: AC220V B: DC24V C: AC110V E: AC24V F: DC12V	P: With manual override	050: 0.5m 200: 2.0m

[Note1] Attach the two M2.5 screws.

Ordering code of wire

CPV T 050



① Model	② Wire	③ Wire length
CPV: CPV series micro-solenoid valve	T: Wire	050: 0.5m 300: 3.0m 200: 2.0m 500: 5.0m

Inner structure

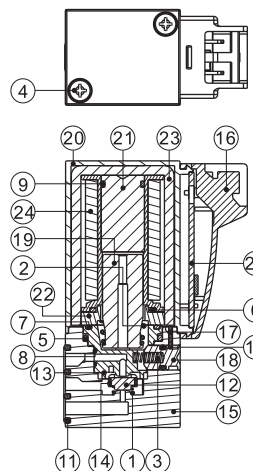

No.	Item	Material	No.	Item	Material
1	Spring	Stainless steel	14	mandril	Resin
2	Spring	Stainless steel	15	Body	Resin
3	Spring	Stainless steel	16	Connector shell	Resin
4	Screw	Carbon steel	17	Manual pin plate	Stainless steel
5	O-ring	NBR	18	Manual pin	Brass
6	O-ring	NBR	19	Movable core	Stainless steel
7	O-ring	NBR	20	Cover	Resin
8	O-ring	NBR	21	Electromagnet	Stainless steel
9	O-ring	NBR	22	Plate	Carbon steel
10	O-ring	NBR	23	U shape bracket	Carbon steel
11	Gasket	NBR	24	Coil	
12	Gasket	NBR	25	PCB assembly	
13	Crater	Resin			

Installation and Application

1. Valve body installation:
Use two M2.5 X 19 screws to mount the valve by 0.4~0.45N.
2. Wiring instruction:
Vertical and horizontal insertion share the same terminal port for different practical applications.
Note: There is no polarity for terminal wire.
3. AC coil is forbidden to connect with other devices.

M2.5 × 19(long) Screw

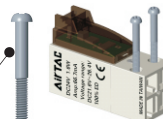

Vertically insert
(Wire and body is vertical)

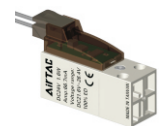

Horizontally insert
(Wire and body is horizontal)

Micro-solenoid valve(3/2 way)

CPV15 Series — Manifold (G)



Specification

Model	CPV15M2F	CPV15M3F	CPV15M4F	CPV15M20F
Fluid	Air(to be filtered by 40 μm filter element)				
Temperature	-20~70°C				
Port size [Note1]	P/R: 1/8" A: Φ4mm(quick connector)				
Applicable valves	CPV15 series micro-solenoid valve				

[Note1] PT thread and G thread are available.

Product feature

1. Integrated installation saves space and reduces additional accessories.
2. Centralized air intake, exhaust, and wiring for quick air circuit checking.
3. Flexible combination and expandability for various applications. Blank plates are optional.

Ordering code

Ordering code for manifold

CPV15M 20F G		
① Model	② Number of stations	③ Thread type
CPV15M: CPV15 series manifold	2F: 2 stations 3F: 3 stations 4F: 4 stations 20F: 20 stations	G: G

Ordering code for blank plate

P-CPV15S R2	
① Model	② Code
CPV15S: CPV15S series integrated solenoid valve	R2: Blank plate for manifold

[Note] 1. Ordering code contains manifold and blank plate.

2. Maximum station up to 20 stations.

3. Blank plate kits contain blank plate, gasket and screw.



Dimensions

PT/G thread

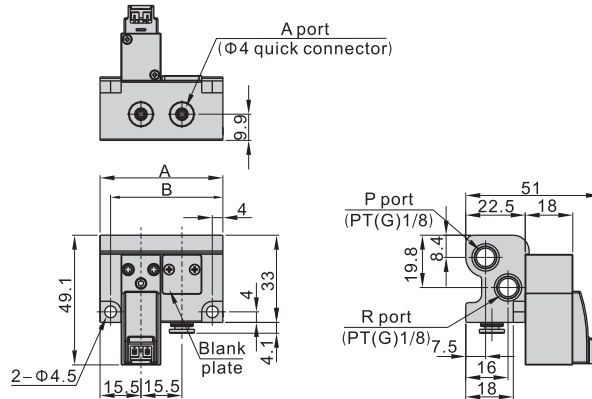

Item\Number of stations	2F	3F	4F	5F	6F	7F	8F	9F	10F	11F	12F	13F	14F	15F	16F	17F	18F	19F	20F
A	46.5	62	77.5	93	108.5	124	139.5	155	170.5	186	201.5	217	232.5	248	263.5	279	294.5	310	325.5
B	38.5	54	69.5	85	100.5	116	131.5	147	162.5	178	193.5	209	224.5	240	255.5	271	286.5	302	317.5

Installation and Application

Assembly of micro-solenoid valve (blank plate) and manifold	Expansion of micro-solenoid valve	A port tubing	Manifold mounting
<p>Mount micro-solenoid valve and manifold by two M2.5 screws as following . Mount blank plate and manifold by two M2.5 countersunk screws as following .</p>	<p>Remove blank plate and install solenoid valve by the assembly instruction.</p>	<p>A port is at the side of manifold with quick connector for tube OD Φ4 mm.</p>	<p>Both sides of manifold attach two installing through-holes, using two M4 hexagon cap screws to fix.</p> <p>Installing through-holes (using two M4 hexagon cap screws to fix)</p>