



# Mini cylinder(Stainless steel)—MI Series

In accordance with ISO6432 standard

## Compendium of MI Series

**Multi-mounting accessories**

LB Type    FA Type    SDB Type    TC Type

**Rolling packed structure**

Front and back cover and stainless steel block adopt riveted rolling packed structure to form a reliable connection.

**Eight bore size are available**

Bore size: 8、10、12、16、20、25、32、40

**Four kinds of back cover type**

CA: Pivot type    U: Perpendicular 90°    R: Axial air-in    CM: Round-end type

**Multi-type cylinder**

MI: Mini cylinder (Double acting)

MIC: Mini cylinder Double acting with cushion

MSI: Mini cylinder (Single acting\_push)

MTI: Mini cylinder (Single acting\_pull)

MID: Mini cylinder(Double rod)

MICD: Mini cylinder(Double rod with cushion)

MIJ: Mini cylinder(Adjustable stroke)

MICJ: Mini cylinder(Adjustable stroke with cushion)

**Multi-kinds of stroke**

**Two kinds of cushion type**

Variable cushion or Bumper

## Criteria for selection: Cylinder thrust

Unit: Newton(N)

Bore size	Rod size	Acting type	Pressure area(mm <sup>2</sup> )	Operating pressure(MPa)							
				0.1	0.2	0.3	0.4	0.5	0.6	0.7	
8	4	Single acting	Push side	50.2	-	3.6	8.6	13.6	18.6	23.6	28.7
			Pull side	37.7	-	1.0	4.8	8.6	12.3	16.1	19.9
		Double acting	Push side	50.2	5.0	10.1	15.1	20.1	25.1	30.1	35.2
			Pull side	37.7	3.7	7.5	11.3	15.1	18.8	22.6	26.4
10	4	Single acting	Push side	78.5	-	5.9	13.8	21.6	29.5	37.3	45.2
			Pull side	65.9	-	3.4	10.0	16.6	23.2	29.8	36.4
		Double acting	Push side	78.5	7.9	15.7	23.6	31.4	39.3	47.1	55.0
			Pull side	65.9	6.6	13.2	19.8	26.4	33.0	39.5	46.1
12	6	Single acting	Push side	113.0	-	10.1	21.4	32.7	44.0	55.3	66.6
			Pull side	84.8	-	4.5	12.9	21.4	29.9	38.4	46.9
		Double acting	Push side	113.0	11.3	22.6	33.9	45.2	56.5	67.8	79.1
			Pull side	84.8	8.5	17.0	25.4	33.9	42.4	50.9	59.4
16	6	Single acting	Push side	201.0	-	14.6	34.7	54.8	74.9	95.0	115.1
			Pull side	172.7	-	8.9	26.2	43.5	60.8	78.0	95.3
		Double acting	Push side	201.0	20.1	40.2	60.3	80.4	100.5	120.6	140.7
			Pull side	172.7	17.3	34.5	51.8	69.1	86.4	103.6	120.9
20	8	Single acting	Push side	314.0	-	25.3	56.7	88.1	119.5	150.9	182.3
			Pull side	263.8	-	15.3	41.6	68.0	94.4	120.8	147.1
		Double acting	Push side	314.0	31.4	62.8	94.2	125.6	157.0	188.4	219.8
			Pull side	263.8	26.4	52.8	79.1	105.5	131.9	158.3	184.7
25	10	Single acting	Push side	490.6	-	43.1	92.2	141.3	190.3	239.3	288.4
			Pull side	412.1	-	27.4	68.6	109.8	151.1	192.3	233.5
		Double acting	Push side	490.6	49.1	98.1	147.2	196.2	245.3	294.4	343.4
			Pull side	412.1	41.2	82.4	123.6	164.8	206.1	247.3	288.5
32	12	Single acting	Push side	804.3	30.2	110.9	191.3	277.1	352.1	432.6	513.0
			Pull side	691.2	19.1	88.2	157.4	226.5	295.6	364.7	438.8
		Double acting	Push side	804.3	80.4	160.9	241.3	321.7	402.2	482.6	563.0
			Pull side	691.2	69.1	138.2	207.4	276.5	345.6	414.7	483.8
40	16	Single acting	Push side	1256.6	64.7	190.3	316.0	441.7	567.3	693.0	818.7
			Pull side	1055.6	44.6	150.1	255.7	361.2	466.8	572.4	677.9
		Double acting	Push side	1256.6	125.7	251.3	377.0	502.6	628.3	754.0	879.6
			Pull side	1055.6	105.6	211.1	316.7	422.2	527.8	633.4	738.9

## Installation and application



- When load changes in the work, the cylinder with abundant output capacity shall be selected.
- Relative cylinder with high temperature resistance or corrosion resistance shall be chosen under the condition of high temperature or corrosion.
- Necessary protection measure shall be taken in the environment with higher humidity, much dust or water drops, oil dust and welding dregs.
- Dirty substances in the pipe must be eliminated before cylinder is connected with pipeline to prevent the entrance of particles into the cylinder.
- The medium used by cylinder shall be filtered to 40 μm or below.
- Anti-freezing measure shall be adopted under low temperature environment to prevent moisture freezing.
- The cylinder shall be carried out test run without load before application. Prior to run, buffer shall be turned to the minimum and gradually released to avoid the damage on cylinder caused by excessive impact.
- The cylinder shall avoid the influence of side load in operation to maintain the normal work of cylinder and extend the service life.
- If the cylinder is dismantled and stored for a long time, please conduct anti-rust treatment to the surface. Anti-dust caps shall be added in air inlet and outlet ports. The front and back cover can not be dismantled, which shall be especially noticed.



# Mini cylinder(Stainless steel, ISO6432)

## MI Series



### Symbol

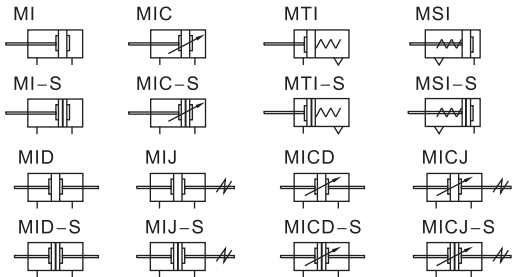

### Product feature

- In accordance with ISO6432 standard( $\Phi 8\sim\Phi 25$ ).
- Front and back cover owns fixed bumper pad which can reduce the impact of direction-change of the cylinder.
- There are several mode of back cover, which makes the installation of cylinder more convenient.
- Front and back cover and stainless steel block adopt riveted rolling packed structure to form a reliable connection.
- Piston rod and cylinder body with the material of stainless steel make the cylinder adapt general working environment with corrosivity.
- There are cylinders and accessories with several specifications for installation for your choice.

### Ordering code

MI 10 x 40 S CA  G

MID 10 x 40 S  G

MIJ 10 x 40-30 S  G



① Model	② Bore size	③ Stroke	④ Adjustable stroke	⑤ Magnet	⑥ Back cover	⑦ Mounting type[Note1]	⑧ Thread type
MI: Mini cylinder(Double acting)	8 10 12 16 20 25 32 40	Refer to stroke table for details	No this code	Blank: Without magnet S: With magnet	Refer below table for details	Blank: No accessories FA: FA type SDB: SDB type LB: LB type TC: TC type	G: G
MIC: Mini cylinder (Double acting with cushion)	16 20 25 32 40						
MSI: Mini cylinder(Single acting_push)	8 10 12 16 20 25 32 40						
MTI: Mini cylinder(Single acting_pull)							
MID: Mini cylinder(Double rod)	16 20 25 32 40		10 20 30 40 50 75 100	No this code	No this code	Blank: No accessories FA: FA type LB: LB type TC: TC type	
MICD: Mini cylinder (Double rod with cushion)							
MIJ: Mini cylinder(Adjustable stroke)	8 10 12 16 20 25 32 40						
MICJ: Mini cylinder(Adjustable stroke with cushion)	16 20 25 32 40						

[Note1] Please refer to page 218~219 for accessory parts.

Model	Back cover	Bore size
MI MSI MTI	CA: Pivot type	$\Phi 8\sim\Phi 25$
	U: Perpendicular 90°	$\Phi 8\sim\Phi 40$
	R: Axial air-in	$\Phi 16\sim\Phi 40$
MIC	CM: Round-end type	$\Phi 16\sim\Phi 40$
	CA: Pivot type	$\Phi 16\sim\Phi 25$
	U: Perpendicular 90°	$\Phi 16\sim\Phi 40$
Others	CM: Round-end type	$\Phi 16\sim\Phi 40$
Others	No this code	

### Specification

Bore size(mm)	8	10	12	16	20	25	32	40
Acting type	Double acting、Single acting_Push、Single acting_Pull							
Fluid	Air(to be filtered by 40 $\mu$ m filter element)							
Operating pressure	Double acting	0.15~1.0MPa(22~145psi)(1.5~10.0bar)						
	Single acting	0.2~1.0MPa(28~145psi)(2.0~10.0bar)						
Proof pressure	1.5MPa(215psi)(15bar)							
Temperature $^{\circ}$ C	-20~70							
Speed range mm/s	Double acting: 30~800				Single acting: 50~800			
Stroke tolerance	0~150 <sup>+1.0</sup> <sub>0</sub>				>150 <sup>+1.5</sup> <sub>0</sub>			
Cushion type	MIC Series: Variable cushion				Other series: Bumper			
Port size [Note1]	M5 x 0.8				1/8"		1/4"	

[Note1] G thread is available.

Add) Refer to P427 for detail of sensor switch.

### Stroke

Bore size (mm)	Standard stroke (mm)	Max.std stroke	Max. stroke	
MI	8	10 15 20 25 30 40 50 60 75 80 100 125 150	150	200
	10	10 15 20 25 30 40 50 60 75 80 100 125 150 160 175 200	200	200
	12	10 15 20 25 30 40 50 60 75 80 100 125 150 160 175 200 250	250	500
MI MIC	16	10 15 20 25 30 40 50 60 75 80 100 125 150 160 175 200 250 300	500	600
	20 25 32 40	350 400 450 500	500	800
MID MIJ	8	10 15 20 25 30 40 50 60 75 80 100	100	-
	10	10 15 20 25 30 40 50 60 75 80 100	100	-
	12	10 15 20 25 30 40 50 60 75 80 100 125 150 160 175 200	200	-
MID MIJ	16 20	10 15 20 25 30 40 50 60 75 80 100 125 150 160 175 200 250 300	300	-
	25	10 15 20 25 30 40 50 60 75 80 100 125 150 160 175 200 250 300	300	-
	32	10 15 20 25 30 40 50 60 75 80 100 125 150 160 175 200 250 300	500	-
MICD MICJ	40	350 400 450 500	500	-
	8 10 12	10 15 20 25 30 40 50	-	-
MSI MTI	16	10 15 20 25 30 40 50 60 75 80 100	-	-
	20 25 32 40	10 15 20 25 30 40 50 60 75 80 100 125 150	-	-

[Note] Consult us for non-standard stroke.



## MI Series

### Inner structure and material of major parts

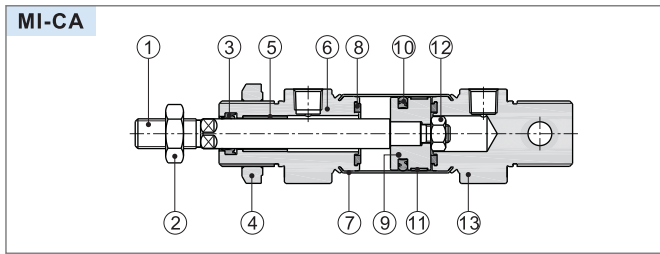

NO.	Item	Material
1	Rod	SUS304
2	Rod nut	Carbon steel
3	Front cover packing	NBR
4	Front cover nut	Carbon steel
5	Bushing	Wear resistant material
6	Front cover	Aluminum alloy
7	Barrel	SUS304
8	Bumper	TPU
9	Piston	SUS304(Φ8~Φ12)\Aluminum alloy(Others)
10	Piston seal	NBR
11	Wear ring	Wear resistant material
12	Nut	Carbon steel
13	Back cover	Aluminum alloy

### Dimensions

#### MI

##### CA Type

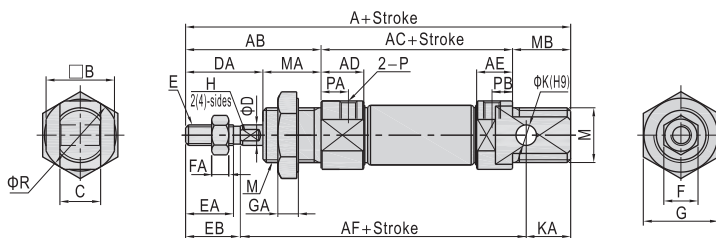

##### U Type

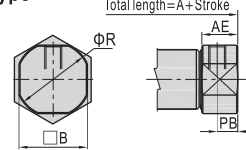

##### R Type

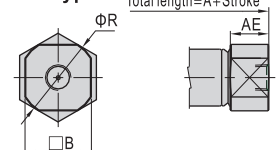

##### CM Type

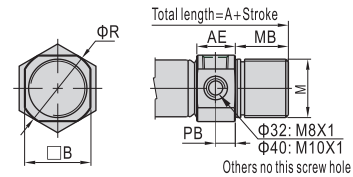

Bore size/Item	A				AB	AC	AD	AE			AF	B	C	D	DA	E	EA	EB	F	FA	G	GA	H	K	KA	M	MA	MB	P	PA	PB			R
	CA	U	R	CM				CA	U/R/CM	U/R/CM																					CA	U/R/CM	CA	
8	86	74	-	-	28	46	11.5	9.5	9.5	64	15	8	4	16	M4×0.7	10.5	12	7	2.2	17	6	-	4	10	M12×1.25	12	12	M5×0.8	7	5	5	17		
10	86	74	-	-	28	46	11.5	9.5	9.5	64	15	8	4	16	M4×0.7	10.5	12	7	2.2	17	6	-	4	10	M12×1.25	12	12	M5×0.8	7	5	5	17		
12	105	88	-	-	38	50	12.5	10.5	10.5	75	18	12	6	21	M6×1.0	14	16	10	5	22	6	5(2-Sides)	6	14	M16×1.5	17	17	M5×0.8	8	6	6	20		
16	111	94	94	111	38	56	12.5	10.5	10.5	82	20	12	6	21	M6×1.0	14.5	16	10	5	22	6	5(2-Sides)	6	13	M16×1.5	17	17	M5×0.8	8	6	6	22		
20	126	106	106	126	44	62	14.5	14.5	14.5	95	25	16	8	24	M8×1.25	18	20	12	6	29	7	6(2-Sides)	8	11	M22×1.5	20	20	1/8"	7.5	7.5	7.5	29		
25	137	114.5	115	137	50	65	16	16	16	104	30	16	10	28	M10×1.25	20.5	22	17	6	29	7	8(4-Sides)	8	11	M22×1.5	22	22	1/8"	8	8	8	33.5		
32	-	125	126	140	58	-	16.5	-	16.5	-	34.5	-	12	28	M10×1.25	17.5	20	17	6	36	7	10(4-Sides)	-	-	M30×1.5	30	14	1/8"	9	-	9	37.5		
40	-	158	158	174	69	-	22	-	22	-	42.5	-	16	34	M12×1.25	21	24	17	7	46	8	14(4-Sides)	-	-	M38×1.5	35	16	1/4"	12	-	12	46.5		

Remark: The dimensions of magnet type cylinder are the same as non-magnet type cylinder.

#### MIC Φ16~Φ25

##### CA Type

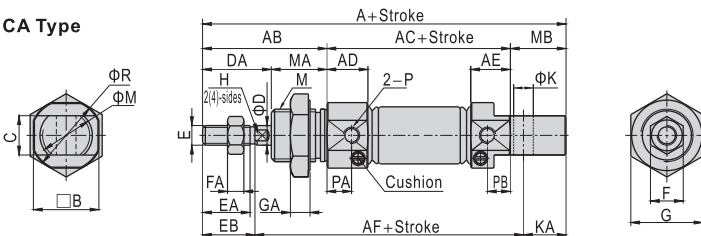

##### U Type

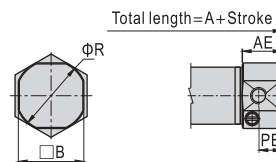

##### CM Type

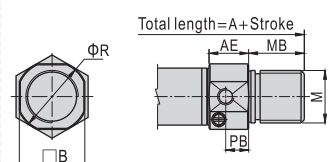

Bore size/Item	A				AB	AC	AD	AE			AF	B	C	D	DA	E	EA	EB	F	FA	G	GA	H	K	KA	M	MA	MB	P	PA	PB	R
	CA/CM	U	U	CA/CM				U	CA/CM	U																						
16	111	94	38	56	12.5	12	12	82	20	12	6	21	M6×1.0	14.5	16	10	5	22	6	5(2-Sides)	6	13	M16×1.5	17	17	M5×0.8	7.5	7	7	22		
20	126	106	44	62	14.5	14.5	14.5	95	25	16	8	24	M8×1.25	18	20	12	6	29	7	6(2-Sides)	8	11	M22×1.5	20	20	1/8"	7.5	7.5	29			
25	137	113.5	50	65	16	16	14.5	104	30	16	10	28	M10×1.25	20.5	22	17	6	29	7	8(4-Sides)	8	11	M22×1.5	22	22	1/8"	8	8	33.5			

Remark: The dimensions of magnet type cylinder are the same as non-magnet type cylinder.

# Mini cylinder(Stainless steel, ISO6432)

## MI Series

MIC  $\phi 32/\phi 40$

### CM Type

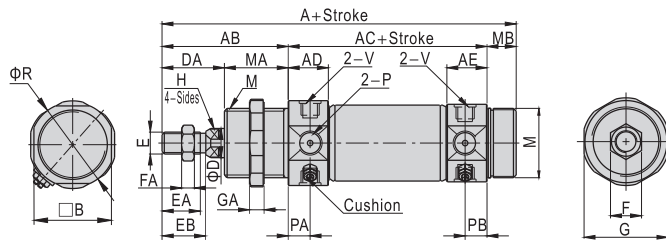

### U Type

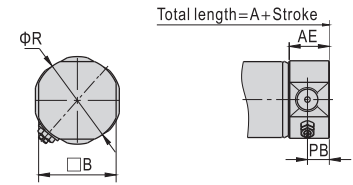

Bore size\Item Back cover	A		AB	AC	AD	AE		B	D	DA	E	EA	EB	F	FA	G	GA	H	M	MA	MB	P	PA	PB		R	V
	U	CM				U	CM																	U	CM		
32	124	140	58	68	16.5	14.5	16.5	34.5	12	28	M10×1.25	17.5	20	17	6	36	7	10(4-Sides)	M30×1.5	30	14	1/8"	9	7.5	9	37.5	M8X1
40	157.5	174	69	89	22	21.5	22	42.5	16	32	M12×1.25	21	24	17	7	46	8	24(4-Sides)	M38×1.5	35	16	1/4"	12	11.5	12	46.5	M10X1

Remark: The dimensions of magnet type cylinder are the same as non-magnet type cylinder.

## MSI

### CA Type

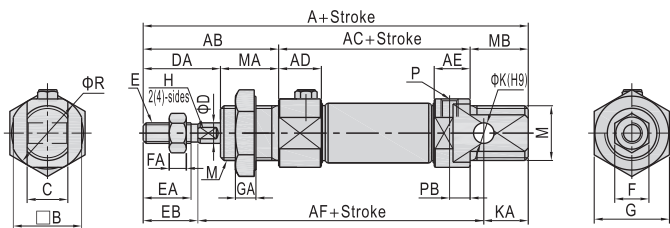

### U Type

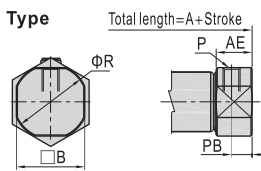

### R Type

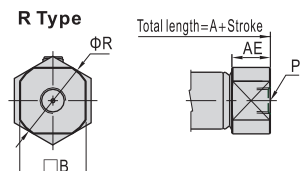

### CM Type

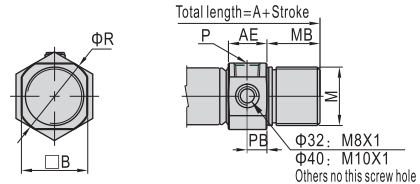

## MTI

### CA Type

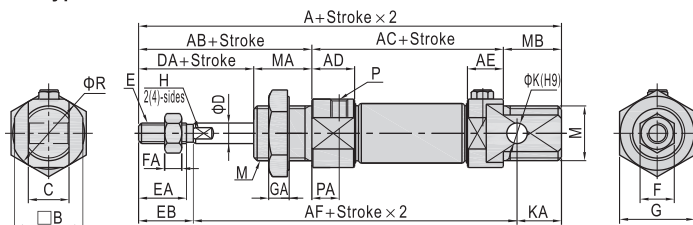

### U Type

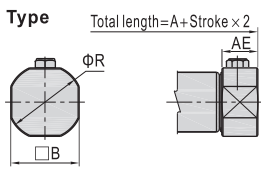

### R Type

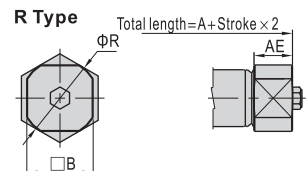

### CM Type

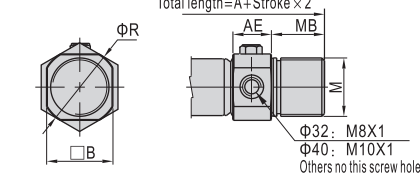

Item Back cover	CA			U			A			R			CM			AB	AC			AD	AF		
	0-50	51-10	101-150	0-50	51-100	101-150	0-50	51-100	101-150	0-50	51-100	101-150	0-50	51-100	101-150		0-50	51-100	101-150		0-50	51-100	101-150
8	111	-	-	99	-	-	-	-	-	-	-	-	-	-	28	71	-	-	11.5	89	-	-	
10	111	-	-	99	-	-	-	-	-	-	-	-	-	28	71	-	-	11.5	89	-	-		
12	130	-	-	113	-	-	-	-	-	-	-	-	-	38	75	-	-	12.5	100	-	-		
16	136	161	-	119	144	-	119	144	-	136	161	-	38	81	106	-	-	12.5	107	132	-		
20	151	176	201	131	156	181	131	156	181	151	176	201	44	87	112	137	14.5	120	145	170	-		
25	162	187	212	139.5	164.5	189.5	140	165	190	162	187	212	50	90	115	140	16	129	154	179	-		
32	-	-	-	150	175	200	151	176	201	165	190	215	58	-	-	-	-	16.5	-	-	-		
40	-	-	-	183	208	233	183	208	233	199	224	249	69	-	-	-	-	22	-	-	-		

Bore size\Item Back cover	AE		B	C	D	DA	E	EA	EB	F	FA	G	GA	H	K	KA	M	MA	MB	P	PA	PB		R
	CA	U/R/CM																				CA	U/CM	
8	9.5	9.5	15	8	4	16	M4×0.7	10.5	12	7	2.2	17	6	-	4	10	M12×1.25	12	12	M5×0.8	7	5	5	17
10	9.5	9.5	15	8	4	16	M4×0.7	10.5	12	7	2.2	17	6	-	4	10	M12×1.25	12	12	M5×0.8	7	5	5	17
12	10.5	10.5	18	12	6	21	M6×1.0	14	16	10	5	22	6	5(2-Sides)	6	14	M16×1.5	17	17	M5×0.8	8	6	6	20
16	10.5	10.5	20	12	6	21	M6×1.0	14.5	16	10	5	22	6	5(2-Sides)	6	13	M16×1.5	17	17	M5×0.8	8	6	6	22
20	14.5	14.5	25	16	8	24	M8×1.25	18	20	12	6	29	7	6(2-Sides)	8	11	M22×1.5	20	20	1/8"	7.5	7.5	7.5	29
25	16	16	30	16	10	28	M10×1.25	20.5	22	17	6	29	7	8(4-Sides)	8	11	M22×1.5	22	22	1/8"	8	8	8	33.5
32	-	16.5	34.5	-	12	28	M10×1.25	17.5	20	17	6	36	7	10(4-Sides)	-	-	M30×1.5	30	14	1/8"	9	-	9	37.5
40	-	22	42.5	-	16	34	M12×1.25	21	24	17	7	46	8	14(4-Sides)	-	-	M38×1.5	35	16	1/4"	12	-	12	46.5

Remark: The dimensions of magnet type cylinder are the same as non-magnet type cylinder.





# Mini cylinder(Stainless steel, ISO6432)

## MI Series

### MID

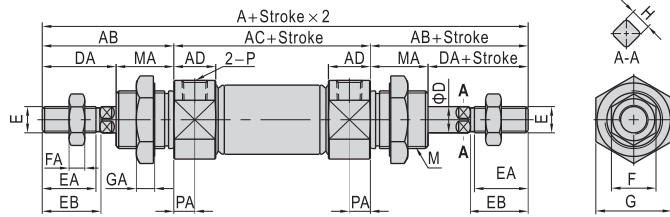

### MIJ

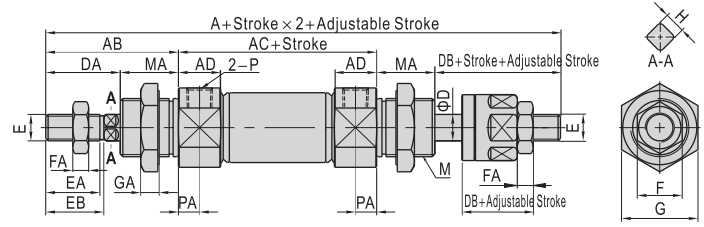

Bore size\Item	A(MID)	A(MIJ)	AB	AC	AD	D	DA	DB	E	EA	EB	F	FA	G	GA	H	M	MA	P	PA
8	104	103	28	48	11.5	4	16	15	M4×0.7	10.5	12	7	2.2	17	6	-	M12×1.25	12	M5×0.8	7
10	104	103	28	48	11.5	4	16	15	M4×0.7	10.5	12	7	2.2	17	6	-	M12×1.25	12	M5×0.8	7
12	128	128	38	52	12.5	6	21	21	M6×1.0	14	16	10	5	22	6	5(2-Sides)	M16×1.5	17	M5×0.8	8
16	134	134	38	58	12.5	6	21	21	M6×1.0	14.5	16	10	5	22	6	5(2-Sides)	M16×1.5	17	M5×0.8	8
20	150	151	44	62	14.5	8	24	25	M8×1.25	18	20	12	6	29	7	6(2-Sides)	M22×1.5	20	1/8"	7.5
25	165	164	50	65	16	10	28	27	M10×1.25	20	22	17	6	29	7	8(4-Sides)	M22×1.5	22	1/8"	8
32	184	183	58	68	16.5	12	28	27	M10×1.25	17.5	20	17	6	36	7	10(4-Sides)	M30×1.5	30	1/8"	9
40	227	222	69	89	22	16	34	29	M12×1.25	21	24	17	7	46	8	14(4-Sides)	M38×1.5	35	1/4"	12

Remark: The dimensions of magnet type cylinder are the same as non-magnet type cylinder.

### MICD Φ16~Φ40

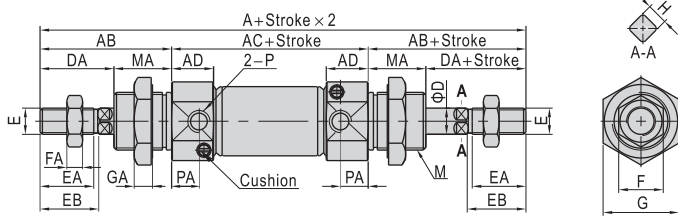

### MICJ Φ16~Φ40

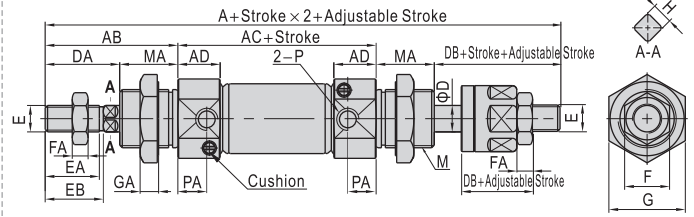

Bore size\Item	A(MICD)	A(MICJ)	AB	AC	AD	D	DA	DB	E	EA	EB	F	FA	G	GA	H	M	MA	P	PA
16	132.5	132.5	38	56.5	12.5	6	21	21	M6×1.0	14.5	16	10	5	22	6	5(2-Sides)	M16×1.5	17	M5×0.8	7.5
20	150	151	44	62	14.5	8	24	25	M8×1.25	18	20	12	6	29	7	6(2-Sides)	M22×1.5	20	1/8"	7.5
25	165	164	50	65	16	10	28	27	M10×1.25	20.5	22	17	6	29	7	8(4-Sides)	M22×1.5	22	1/8"	8
32	184	183	58	68	16.5	12	28	27	M10×1.25	17.5	20	17	6	36	7	10(4-Sides)	M30×1.5	30	1/8"	9
40	227	221	69	89	22	16	34	28	M12×1.25	21	24	17	7	46	8	14(4-Sides)	M38×1.5	35	1/4"	12

Remark: The dimensions of magnet type cylinder are the same as non-magnet type cylinder.

## List for ordering code of accessories

Accessories Bore size	Mounting accessories				Knuckle				Sensor switch					
	LB	FA	SDB	TC	I	Y	F	U	CS1-M□	DS1-M□	CS1-F	DS1-F	CS1-U	DS1-U
8	F-MI10LB	F-MI8FA	F-MI8SDB	F-MI10TC	F-M4X070I	F-M4X070Y	F-M4X070F	F-M4X070U	CS1-M-S08	DS1-M-S08				
10									CS1-M-S10	DS1-M-S10				
12	F-MI12LB	F-MA16FA	F-MI12SDB	F-MI12TC	F-M6X100I	F-M6X100Y	F-M6X100F	F-M6X100U	CS1-M-S12	DS1-M-S12				
16									CS1-M-S16	DS1-M-S16				
20	F-MI20LB	F-MA20FA	F-MI20SDB	F-MI20TC	F-M8X125I	F-M8X125Y	F-M8X125F	F-M8X125U	CS1-M-S20	DS1-M-S20	CS1-F	DS1-F	CS1-U	DS1-U
25									CS1-M-S25	DS1-M-S25				
32	F-MI32LB	-	F-MI32SDB	F-MI32TC	F-M10X125I	F-M10X125Y	F-M10X125F	F-M10X125U	CS1-M-S32	DS1-M-S32				
40									CS1-M-S40	DS1-M-S40				

## Accessory selection

Accessories Cylinder model	Mounting accessories	Knuckle [Note 1]				Sensor switch						
		LB	FA	SDB	TC	I	Y	U	F	C(D)S1-M	C(D)S1-F	C(D)S1-U
MI	Standard	●	●	●	●	●	●	●	●	×	×	×
MIC	With magnet	●	●	●	●	●	●	●	●	●	●	●
MSI	Standard	●	●	●	●	●	●	●	●	×	×	×
MTI	With magnet	●	●	●	●	●	●	●	●	●	●	●
MID	Standard	●	●	×	●	●	●	●	●	×	×	×
MICD	With magnet	●	●	×	●	●	●	●	●	●	●	●
MIJ	Standard	●	●	×	●	●	●	●	●	×	×	×
MICJ	With magnet	●	●	×	●	●	●	●	●	●	●	●

## Material of accessories

Accessories Bore size	Mounting accessories				Knuckle			
	LB	FA	SDB	TC	I	Y	F	U
8~40	△	△	△	▲	□	□	□	□

▲—SUS304; △—SPCC; □—Carbon steel;

[Note 1] Please refer to P415~418 for knuckle detail.

# Mini cylinder(Stainless steel, ISO6432)

## MI Series—Accessories

### Dimensions

#### LB

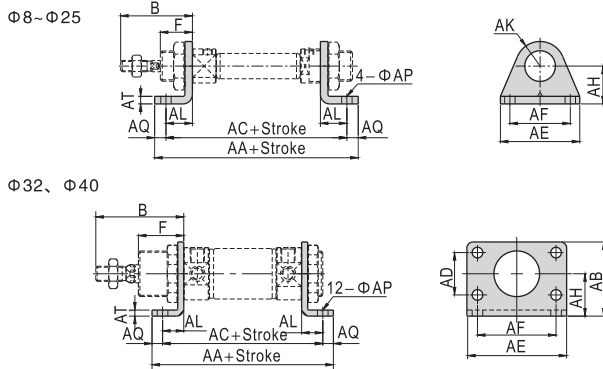

Bore size\Item	AA	AB	AC	AD	AE	AF	AH	AK	AL	AP	AQ	AT	B	F
8	78	-	68	-	35	25	16	10	11	4.5	5	2	28	12
10	78	-	68	-	35	25	16	10	11	4.5	5	2	28	12
12	90	-	78	-	42	32	20	13	14	5.5	6	2.5	38	17
16	96	-	84	-	42	32	20	13	14	5.5	6	2.5	38	17
20	112	-	96	-	54	40	25	20	17	7	8	3	44	20
25	115	-	99	-	54	40	25	20	17	7	8	3	50	22
32	110	49	96	28	66	52	28	-	14	7	7	3.5	58	30
40	149	58	129	30	80	60	33	-	20	9	10	3.5	69	35

#### TC

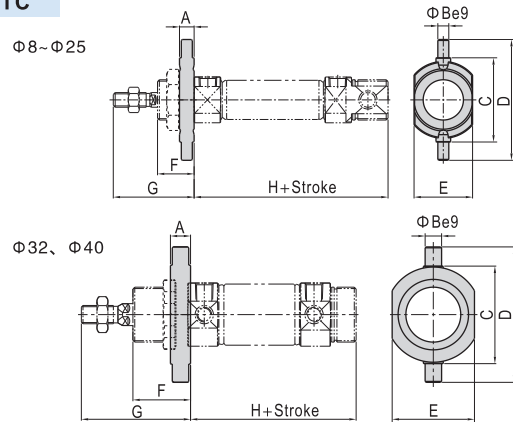

Bore size\Item	A	B	C	D	E	F	G	H
8	6	4	26	38	20	12	28	58
10	6	4	26	38	20	12	28	58
12	8	6	38	58	25	17	38	67
16	8	6	38	58	25	17	38	73
20	8	6	46	66	32	20	44	82
25	8	6	46	66	32	22	50	87
32	11	9	54	74	45	30	58	82
40	12	10	64	84	55	35	69	101

#### FA

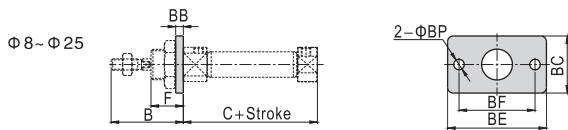

Bore size\Item	B	C	BB	BC	BE	BF	BP	F
8	28	46	2	22	40	30	4.5	12
10	28	46	2	22	40	30	4.5	12
12	38	50	3	30	52	40	5.5	17
16	38	56	3	30	52	40	5.5	17
20	44	62	3.5	40	66	50	7	20
25	50	65	3.5	40	66	50	7	22

#### SDB

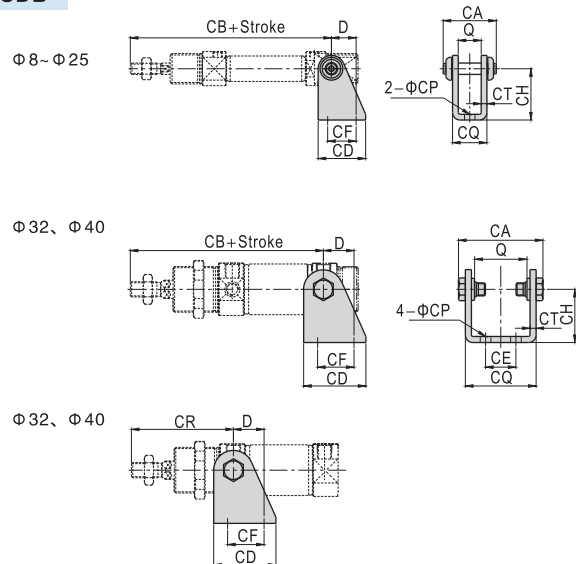

Bore size\Item	D	Q	CA	CB	CD	CE	CF	CH	CP	CQ	CT	CR
8	11	8.1	18.4	76	20	-	12.5	24	4.5	13.1	2	-
10	11	8.1	18.4	76	20	-	12.5	24	4.5	13.1	2	-
12	13	12.1	28	91	25	-	15	27	5.5	18.1	2	-
16	13	12.1	28	98	25	-	15	27	5.5	18.1	2	-
20	16	16.1	38	115	32	-	20	30	7	24.1	2.5	-
25	16	16.1	38	126	32	-	20	30	7	24.1	2.5	-
32	20	34.6	55.5	117	41	20	24	35	7	46.6	3	67
40	27	42.6	69.6	146	52	28	30	40	9	58.6	3	81

[Note] SDB is attached with relevant PIN.

