



Naturally high-quality, improved by technology

# Fluidfit

Fittings for potable water, drink dispensers and beverages



We are 100% customer focused, offering a complete range of high quality products with an industry leading customer service.

Our goal is the complete customers satisfaction, respecting and answering their specific requirements with the offer of constant improvements in service and costs.

Our professional skills and resources are our strength points enabling us to manufacture high quality products that can be offered successfully over the world.

La nostra azienda è al 100% focalizzata sul cliente, offrendogli una gamma completa di prodotti di alta qualità e sostenendolo al meglio.

Il nostro obiettivo è la completa soddisfazione del cliente, rispettando e rispondendo alle sue specifiche richieste all'insegna dei continui miglioramenti nell'efficienza dei propri servizi e nei costi.

Le nostre risorse e competenze professionali sono sicuramente i nostri punti di forza che ci permettono di produrre prodotti di alta qualità e di operare con successo in tutto il mondo.





CDC Pneumatics is a company specialized in Pneumatics and Water fittings, accessories and tubing since 1983.

The continuous developments, technological improvements, and constant innovation ensures we can offer the highest quality level of products.

Our main interest is to meet our customers requirements and, for this reason, CDC Pneumatics keeps moving forward in order to offer the best quality products because CUSTOMER SATISFACTION comes first.

CDC Pneumatics è un'azienda specializzata nella pneumatica e in raccordi per acqua, accessori e tubi dal 1983.

I continui sviluppi e migliorie, l'innovazione tecnologica e le costanti sfide garantiscono il più alto livello di qualità dei nostri prodotti.

Il nostro interesse principale è andare incontro alle esigenze dei nostri Clienti e per questa ragione CDC Pneumatics è sempre in continuo movimento in modo da avere nella propria gamma i prodotti con i più alti standard di qualità perché la SODDISFAZIONE DEL CLIENTE viene prima di tutto.

---

Fittings for Potable Water, Drinks Dispensers and Beverages.  
"Naturally High-Quality, improved by Technology"

---

## Technical Information

### MATERIALS

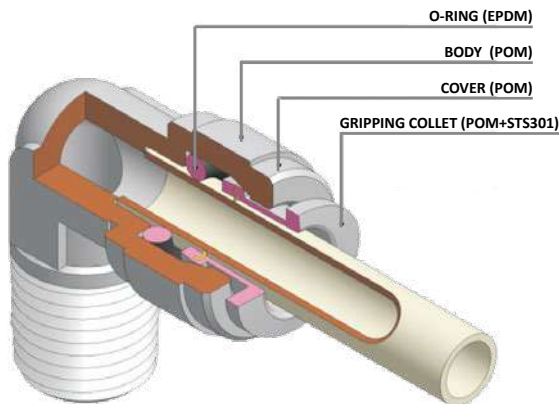

Fluidfit products are designed for water, food and air contact but can be used with selected gases, vacuum & other liquids.

Easy actions allow the tube to be connected and released quickly, saving time and expenses.

Fluidfit products are made of NSF and ACS approved non-toxic material. According to DVGW worksheet W 270, materials which are used in the drinking water sector, must have a surface which excludes an unwanted surface fouling by microorganisms.

CDC Fluidtech Europe's POM (colors Black, Grey and Natural) is suitable for the use in drinking water systems according to the results of the microbiological examinations pursuant to DVGW Technical standard W 270 (11/2007).

Fluidfit meets the requirements for the product group:

Fittings for pipes with DN < 80 mm in contact with cold water (23°C).

I prodotti della gamma Fluidfit sono progettati per acqua, applicazioni alimentari e aria ma possono essere anche usati con gas selezionati, vuoto e altri liquidi.

Movimenti semplici permettono l'inserimento e lo sgancio del tubo velocemente, risparmiando tempo e costi.

Il materiale dei prodotti Fluidfit non è tossico ed è approvato dalla NSF e ACS. Concordemente a quanto disposto da DVGW normativa W270, i materiali utilizzati nel settore dell'acqua destinata al consumo umano, devono presentare una superficie che escluda una contaminazione superficiale indesiderata da parte di microrganismi.

Il POM utilizzato da CDC Fluidtech Europe (di colore Nero, Grigio e Naturale) è adatto per l'utilizzo in sistemi di acqua potabile in base ai risultati delle analisi microbiologiche ai sensi della normativa DVGW W 270 (11/2007).

Fluidfit soddisfa i requisiti per la classe di prodotti:

Raccordi per tubi con DN < 80 mm a contatto con acqua fredda (23°C).

### COLOR CODES

HUT 0606 B	B (BLACK) (metric)	
HUT 3/8-3/8 G	G (GREY) (imperial)	

### MAXIMUM TORQUE VALUES FOR BSP, BSPT AND NPT PLASTIC THREADS

Threads	1/8"	1/4"	3/8"	1/2"	3/4"
Max Torque	1.5 Nm	1.5 Nm	3.0 Nm	3.0 Nm	4.0 Nm

### TECHNICAL DATA

Fluid Type	Water, Beverages, Vacuum, Compressed Air, Gases & Liquids suitable with Construction Materials
Working temperature	from -20°C to 98°C: dry air from 1°C to 98°C: air & fluids * *Please be advised that NSF standards cover only the temperature range from 1°C to 70°C. System performances always depend from fittings, tubes and possible other items and accessories used. It is responsibility of the users to cross check the technical features of each SINGLE component in order to avoid possible failures and damages.
Pressure	From - 750 mmHg up to 20 Bar Depending from the tubes & temperatures applied.
Tube Type (Plastic)	Polyethylene (PE) - Polyamide (PA) Polyurethane (PU) - PTFE - FEP
Tube Type (Soft Metal)	Brass - Copper - Mild Steel - Aluminum
Tube Type (Hard Metal)	Please check page 5 to create groove

Tipo di Fluido	Acqua, Bevande, Vuoto, Aria Compressa, Gas & Liquidi idonei con i materiali costruttivi
Temperatura d'esercizio	da -20°C a 98°C: aria secca da 1°C a 98°C: aria & fluidi * *Si prega di notare che gli standard NSF coprono solo il range di temperatura da 1 °C a 70 °C. Le performance di sistema dipendono sempre dai raccordi, dai tubi e dai possibili altri articoli e accessori utilizzati. E' responsabilità dell'utente fare un controllo incrociato delle caratteristiche tecniche dei SINGOLI componenti in modo da evitare possibili perdite e pericoli.
Pressione d'esercizio	da - 750 mmHg a 20 Bar A seconda dei tubi e temperature utilizzate
Tipo di Tubi (Plastici)	Polietilene (PE) - Poliammide (PA) Poliuretano (PU) - PTFE - FEP
Tipo di Tubi (Metalli teneri)	Ottone - Rame - Acciaio tenero - Alluminio
Tipo di tubi (Metalli duri)	Si prega di controllare a pag. 5 per creare groove

## Technical Information

### WORKING PRESSURES & TEMPERATURES

∅ / °C	-20°C	1 °C *	25 °C *	70 °C *	98 °C
4 mm 5/32"	0 Bar --> 8 Bar with dry air only  0 Bar --> 8 Bar solo con aria secca	- 750 mmHg --> 20 Bar	- 750 mmHg --> 20 Bar	- 750 mmHg --> 16 Bar	- 750 mmHg --> 10 Bar
6 mm 3/16" - 1/4"		- 750 mmHg --> 20 Bar	- 750 mmHg --> 20 Bar	- 750 mmHg --> 16 Bar	- 750 mmHg --> 10 Bar
8 mm 5/16"		- 750 mmHg --> 20 Bar	- 750 mmHg --> 20 Bar	- 750 mmHg --> 16 Bar	- 750 mmHg --> 10 Bar
10 mm 3/8"		- 750 mmHg --> 16 Bar	- 750 mmHg --> 16 Bar	- 750 mmHg --> 14 Bar	- 750 mmHg --> 10 Bar
12 mm 1/2"		- 750 mmHg --> 14 Bar	- 750 mmHg --> 14 Bar	- 750 mmHg --> 8 Bar	- 750 mmHg --> 6 Bar
15 mm		- 750 mmHg --> 14 Bar	- 750 mmHg --> 14 Bar	- 750 mmHg --> 8 Bar	- 750 mmHg --> 6 Bar
22 mm		- 750 mmHg --> 14 Bar	- 750 mmHg --> 14 Bar	- 750 mmHg --> 8 Bar	- 750 mmHg --> 6 Bar

\*: temperatures and pressures indicated refers to the NSF standards limits. Please, contact our technical department for higher temperature and/or pressure application needs.

System performances always depend from fittings, tubes and possible other items and accessories used. It is responsibility of the users to cross check the technical characteristics of each single component in order to avoid possible failures and dangers.

\*: temperature e pressioni indicate si riferiscono ai limiti standard della NSF. Vi preghiamo di contattare il nostro ufficio tecnico per applicazioni ed esigenze con temperature e/o pressioni più elevate.

Le performance di sistema dipendono sempre dai raccordi, dai tubi e possibili altri articoli e accessori utilizzati. E' responsabilità dell'utente fare un controllo incrociato delle caratteristiche tecniche dei singoli componenti in modo da evitare possibili perdite e pericoli.

### PIPE GROOVE - HARD METALLIC TUBE

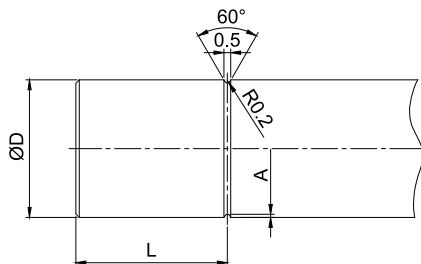

∅D (mm)	L	A
4	7,6	0,23
6	8,0	0,23
8	9,0	0,23
10	11,0	0,23
12	12,7	0,23
15	15,0	0,23
22	17,4	0,23

∅D (inch)	L	A
5/32	7,6	0,23
3/16	7,7	0,23
1/4	9,4	0,23
5/16	9,0	0,23
3/8	11,0	0,23
1/2	12,7	0,23

When using metallic tubing, please deburr the tubes ends to avoid potential cutting or other damages to the o-ring.

Qualora si utilizzino tubi metallici è necessario sbavare le parti terminali del tubo al fine di evitare tagli o altri danni agli o-ring.

## Technical Information

### INSTRUCTIONS

We recommend to read and follow all the instructions, precautions and warnings contained in this catalogue before using the products in pressurized systems. Failure to follow all instructions, precautions and warnings may result in bodily harm or property damages. CDC Fluidtech Europe disclaims any responsibility in case of damages for wrong use of the products.

Si raccomanda di leggere e seguire attentamente le presenti istruzioni e di rispettare le precauzioni e gli avvertimenti contenuti nel presente documento prima dell'utilizzo dei prodotti in sistemi pressurizzati. L'inosservanza delle istruzioni, delle precauzioni e degli avvertimenti che seguono potrebbe causare danni a persone e/o cose. CDC Fluidtech Europe declina ogni tipo di responsabilità per danni derivanti dall'improprio uso dei prodotti.

### HOW TO CONNECT

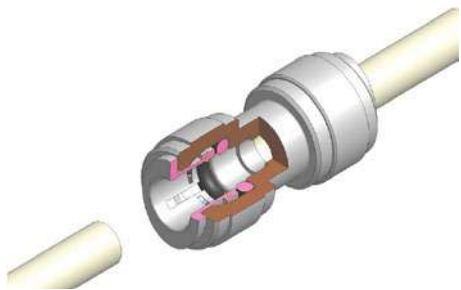

1

Make sure that the tube size and the push-in system size of the fittings are the same. Cut square (90° angle) the part of the tube that has to be inserted into the fittings using the proper tube cutter.

Make sure that the tube used is clean and does not present any scratch, crack, cut or deformity.

Before inserting the tube, please remove any possible obstruction inside the fitting.

Assicurarsi che il tubo ed il sistema ad innesto rapido del raccordo siano della stessa misura. Tagliare ad angolo retto la parte di tubo che dovrà essere inserita nel raccordo mediante l'apposita pinza tagliatubo. Assicurarsi che il tubo utilizzato sia perfettamente pulito e che non presenti tagli, rotture, crepe o deformità. Prima dell'inserimento del tubo rimuovere ogni possibile ostruzione dall'interno del raccordo.

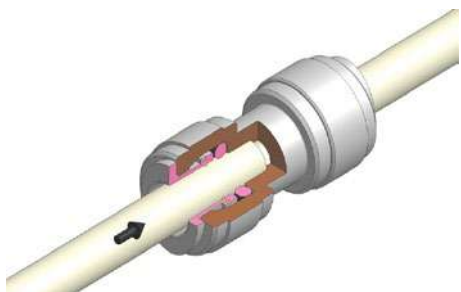

2

Make sure that the tube is correctly and fully inserted.

Inserting the tube into the fitting requires a moderate strain. The tube and the fitting should not be scratched or damaged during the insertion, otherwise there may be leaks or further wrong functions.

Please connect the tube by hands, without using any kind of tool, whether dedicated or not.

Assicurarsi che il tubo sia correttamente e completamente inserito. L'inserimento del tubo richiede uno sforzo moderato. Il tubo ed il raccordo non devono essere graffiati o danneggiati durante l'inserimento, in caso contrario potrebbero esserci perdite o malfunzionamenti. Eseguire l'inserimento manualmente, senza l'utilizzo di strumenti, siano essi dedicati o improvvisati.

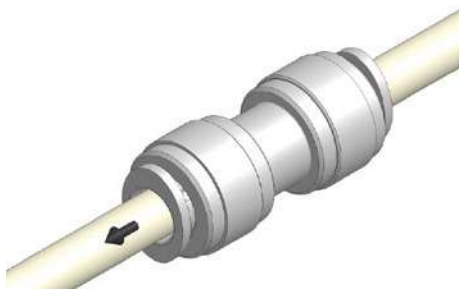

3

To make sure that the fitting is properly connected to the tube, please pull it once without releasing the collet.

Al fine di accertarsi che il tubo sia correttamente inserito, tirare lo stesso senza agire sul colletto di sgancio.

## Technical Information

### INSTRUCTIONS

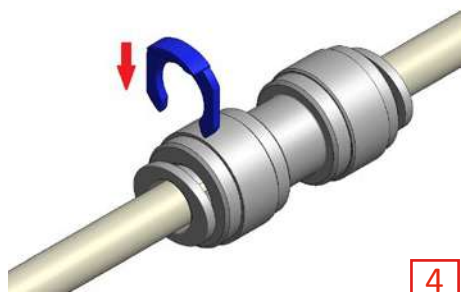

4

After pulling, insert a locking clip of the right dimension between the fitting body and the collet.

Dopo la trazione interporre l'apposita clip di bloccaggio della misura adeguata tra il corpo del raccordo ed il colletto di sgancio e spingere nuovamente il tubo sino al posizionamento in sede.

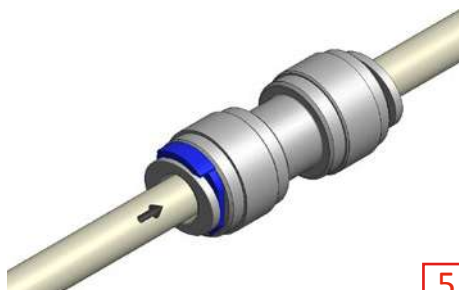

5

Push once more the tube into the fitting for a complete insertion. The use of our locking clips avoids accidental disconnections of the tube and eliminates any play between the tube and the fitting. All the performance limits indicated in this catalogue are related to the systems assembled with locking clips installed.

Spingere nuovamente il tubo nel raccordo fino a completo inserimento. L'utilizzo delle nostre clip di bloccaggio elimina disconnessioni accidentali del tubo ed elimina ogni gioco tra il tubo e il raccordo. Tutti i limiti di performance indicati in questo catalogo sono relativi al sistema assemblato con clip di bloccaggio installate.

### HOW TO DISCONNECT

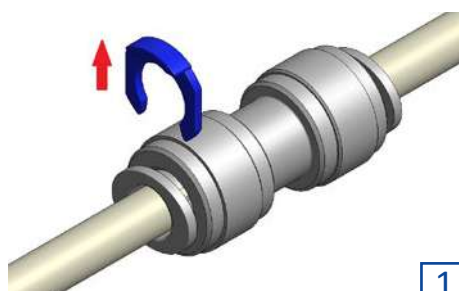

1

Make sure that the pressure has been completely eliminated from the system before disassembling the tube. In order to disconnect the tube, remove the locking clip first.

Assicurarsi che la pressione sia stata completamente eliminata dal sistema prima di sganciare il tubo. Per sganciare il tubo, togliere la clip di bloccaggio.

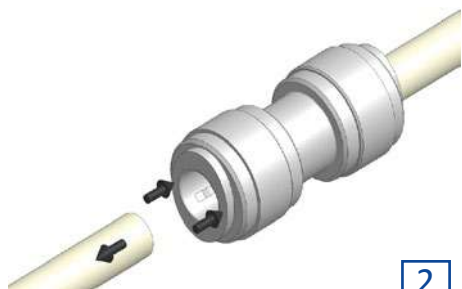

2

Push the collet in the direction of the body of the fitting and pull the tube keeping the collet pushed in order to disconnect the tube from the fitting.

Premere il colletto di sgancio in direzione del corpo del raccordo e mantenerlo premuto mentre si sfila il tubo dal raccordo.

Fittings and tubes can be reused providing that they are not ruined and correctly working. It is possible to reuse them only in case of maintenance and only using the same fluid used before. The reuse refers to the push-in system only, being not guaranteed for the threaded part of the fittings. In case of reuse of a tube, the part previously inserted into the fitting has to be cut and the whole tube has to be verified.

I raccordi ed i tubi sono riutilizzabili a condizione che gli stessi siano integri e perfettamente funzionanti. Il riutilizzo deve avvenire sempre e soltanto in caso di manutenzione e per lo stesso fluido precedentemente utilizzato. Il riutilizzo si riferisce al solo sistema di innesto rapido e non è garantito in caso di raccordi filettati. Il tubo riutilizzato deve essere preventivamente verificato e la parte precedentemente inserita nel raccordo deve essere tagliata.



## Technical Information

---

### WARNINGS AND PRECAUTIONS

In case of use with chemicals, it is responsibility of the user/customer to previously check the chemical compatibility of the fluid with the construction materials of the fittings and of the tubes.

Do not disassemble or modify the individual products as this may cause product malfunctions, leaks or failure. In any case the tampering (modifications or disassembling) of the products causes the decay of the guarantee.

Do not over-stress the products by rotation, twist, bending, chock, fatigue or other excess forces. This may damage the fittings and cause malfunctions, leaks or failure.

Do not use the products where ambient temperature and/or fluid temperature and pressure may exceed the indicated limits.

Do not use sealing systems other than Teflon tape to seal threaded connections.

If your plumbed line is used as an electrical ground, you must use a jumper wire to provide continuity across plastic fittings and metal tubing.

Never press collets towards the body unless you need to separate the tube from the fitting in an unpressurized line. Please, follow the instructions above.

CDC Fluidtech Europe reserves the right to modify the products from time-to-time when required by quality improvements and by market requirements. The actual products may differ from the pictures and drawings shown in this catalogue.

We recommend to assemble tubes, fittings, accessories and other products using Fluidfit products indicated as combinable. The failure in using the recommended products cause the decay of the guarantee. The customer is in charge of checking the performance of the products after the installation.

While connecting the tube, please make sure that it is correctly inserted into the proper fitting seat. Please, note that the tube may result well gripped even if it is not completely inserted into the seat. This may cause failures and leakages. In this case push the tube again into the fitting in order to be sure that it is completely inserted.

When using metallic tubing, please deburr the tubes ends to avoid potential cutting or other damages to the o-ring.

When using theraded fittings, please be careful not to over-torque the fitting as this may damage the fitting and cause a leak or other failure, immediatelly or after the installation.

---

All the official documentations related to certifications & conformity declarations are available on demand.  
This product range is in continuous updating, please check with our sales department for any kind of additional request.

**ALL 2D AND 3D TECHNICAL DRAWINGS ARE AVAILABLE ON DEMAND**

---

## Technical Information

---

### CONDIZIONI DI UTILIZZO E PRECAUZIONI

In caso di utilizzo con agenti chimici, è responsabilità dell'utente/cliente controllare preventivamente la compatibilità chimica del fluido con i materiali costruttivi dei raccordi e dei tubi.

Non smontare o modificare i singoli raccordi e prodotti poiché questo potrebbe causare malfunzionamenti e/o perdite. In ogni caso la manomissione dei prodotti comporta il decadimento della garanzia.

Non sottoporre i raccordi ad eccessi di stress derivanti da rotazioni, scuotimenti, curvature, colpi, fatica o altri tipi di forze. Ciò potrebbe causare malfunzionamenti e perdite.

Non usare i prodotti in ambienti o con fluidi che eccedono le temperature e le pressioni limite indicate.

Non utilizzare sistemi di tenuta diversi dal nastro teflon per le filettature.

In caso di utilizzo delle condutture come messa a terra si raccomanda di realizzare un ponte per garantire la continuità tra i tubi. I raccordi sono realizzati in materiale plastico non conduttore.

Non premere mai il colletto di sgancio se non in caso di necessità di disconnessione del tubo e seguendo le istruzioni già fornite.

I prodotti possono essere modificati da CDC Fluidtech Europe in base alle richieste derivanti da miglioramenti di qualità o dal mercato. I prodotti attuali possono differire dai disegni rappresentati a catalogo.

L'accoppiamento tra tubi, raccordi ed accessori deve avvenire con prodotti Fluidfit ed espressamente previsti come abbinabili pena il decadimento di qualsiasi tipo di garanzia. La verifica della funzionalità post installazione è a carico del cliente.

Durante l'inserimento del tubo verificare sempre che lo stesso sia posizionato completamente nella sua sede all'interno del raccordo. E' infatti possibile che il tubo venga graffiato correttamente anche se non completamente in sede. Questa situazione potrebbe causare perdite. Spingere nuovamente il tubo per assicurarsi che lo stesso sia completamente inserito.

Qualora si utilizzino tubi metallici è necessario sbavare le parti terminali del tubo al fine di evitare tagli o altri danni agli o-ring.

In caso di utilizzo di raccordi filettati, si raccomanda di porre la massima attenzione durante l'avvitamento e di non eccedere le coppie di serraggio indicate poiché ciò potrebbe causare rotture e perdite.

---

Tutte le documentazioni ufficiali legate alle certificazioni e dichiarazioni di conformità sono disponibili su richiesta. Questa gamma di prodotti sono in continuo aggiornamento. Vi preghiamo di verificare con il nostro ufficio vendite eventuali richieste aggiuntive.

**TUTTI I DISEGNI 2D E 3D TECNICI SONO DISPONIBILI SU RICHIESTA**

---

## Certifications & Conformity Desclarations



WRAS

Fluidfit standard fittings and flow regulators are conformed to the UK standards for potable water

I raccordi ed i regolatori di flusso Fluidfit sono conformi agli standard previsti dal mercato del Regno Unito per l'acqua potabile



EC 1935/2004

Materials and articles intended to come in contact with food

Materiali e articoli a contatto con alimenti



D.M. 174/2004

Materials and objects can be used in fixed catching installations, adduction treatment and water distribution for human consumption

Materiali e oggetti che possono essere utilizzati negli impianti fissi di captazione, trattamento adduzione e distribuzione delle acque destinate al consumo umano



ICIM  
Food contact materials

Products and components in contact with food according to FCM (Food Contact Materials) regulations

Prodotti e componenti a contatto con alimenti secondo disposizioni MOCA



ICIM  
Water contact materials

0415CS Products and components in contact with water intended for human consumption (drinking water)

0415CS Prodotti e componenti utilizzati a contatto con acqua destinata al consumo umano (acqua potabile)



ACS

Materials and objects can be used in fixed catching installations, adduction treatment and water distribution for human consumption

Materiali e oggetti che possono essere utilizzati negli impianti fissi di captazione, trattamento adduzione e distribuzione delle acque destinate al consumo umano



NSF51 - NSF61

NSF

Food Equipment Materials  
Drinking Water  
System Components

Materiali delle attrezzature alimentari – Componenti dei sistemi di acqua potabile.

**W270**

DVGW W270  
Drinking water  
approval for materials

According to DVGW worksheet W 270, materials are tested regarding the growth of microorganisms

Concordemente a quanto disposto da DVGW normativa W270, i materiali sono testati circa la crescita di microrganismi

**KTW**

KTW Guideline  
cold water (23°C)

Fluidfit was tested according to the Guideline on the hygienic assessment of organic materials in contact with drinking water of the German Environment Agency

Fluidfit è stato testato secondo la linea guida per la valutazione igienica dei materiali organici a contatto con l'acqua potabile dell'Agenzia Tedesca dell'Ambiente



REACH

Entry, estimate, authorization and restriction of the chemical substances

Registrazione, valutazione, autorizzazione e restrizione delle sostanze chimiche



RoHS 3

Restriction of the use of certain hazardous substances in electrical and electronic equipment

Restrizione nell'utilizzo di determinate sostanze pericolose nelle attrezzature elettriche ed elettroniche

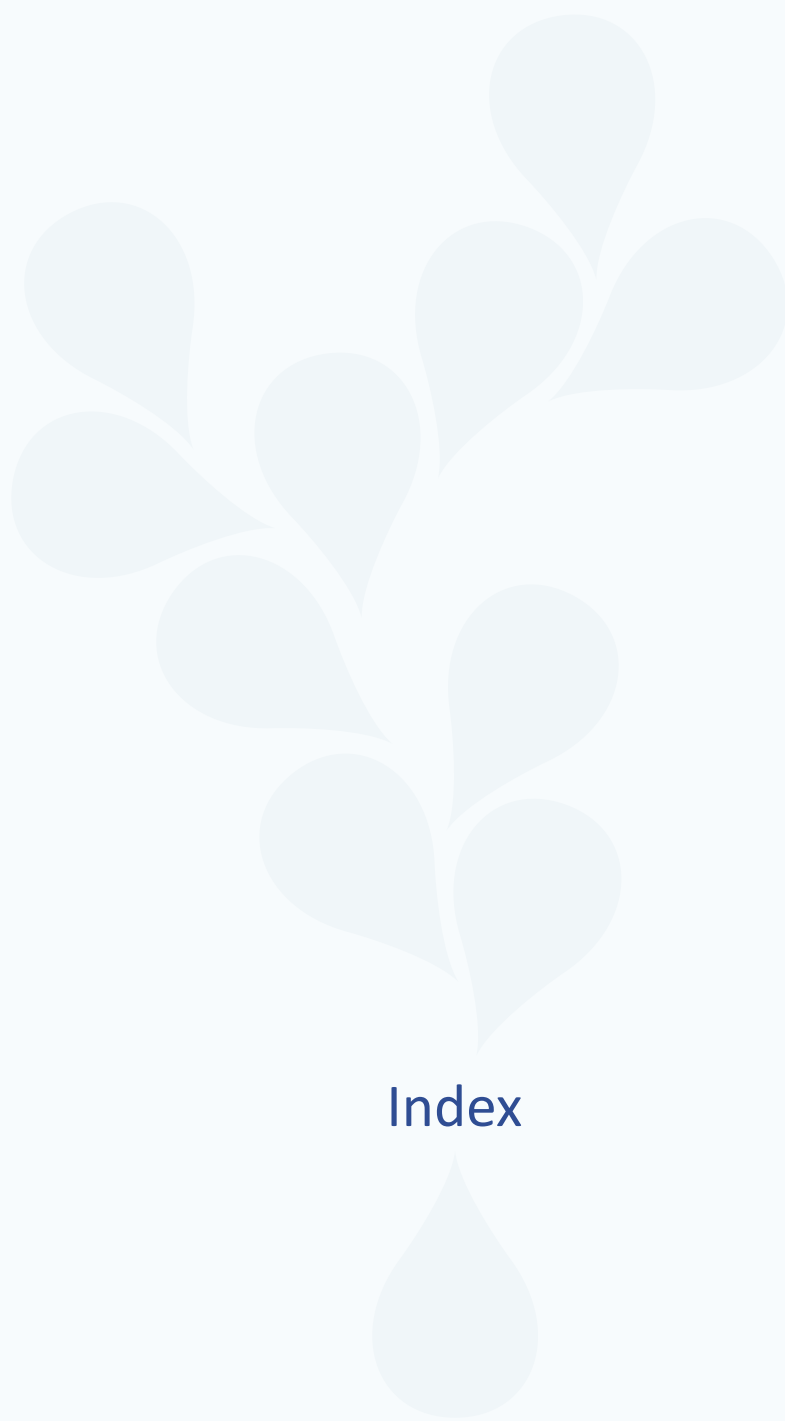

## Index

# Fluidfit

Fittings for potable water, drink dispensers and beverages

## Index

### Metric Fittings



HPC-R  
17



HPC-G  
17



HPC-N  
17



HCF-G  
18



HCF-UNF  
18



HCF-UNS  
19



HCF-NH  
19



HPL-R  
19



HPL-N  
20



HMM  
20



HGJ  
20



HCJ-R  
21



HCJ-G  
21



HLJ  
22



HSJ  
22



HCBB  
22



HUC  
23



NEW HUGL  
23



HUL  
24



HUT  
24



HUY  
25



HZA  
25



HCJB  
25



HLJB  
26



HPP  
26



HPF  
26



HRPL-R  
27



HRPL-G  
27



HRPT-R  
27



HRPT-G  
28



HRST-R  
28



HRST-G  
28



HRWT-R  
29



HRWT-G  
29



HUFF  
29

## Index

### Inch Fittings

					
HPC-R 31	HPC-G 31	HPC-N 31	HPC-MFL 32	HCF-G 32	HCF-N 32
					
HCF-UN 33	HCF-UNF 33	HCF-UNS 33	HCF-NH 33	HPL-N 34	HMM 34
					
HGJ 34	HCJ-N 35	HLJ 35	NEW HTJ 35	HSJ 36	NEW HBUJ 36
					
HUC 36	HUL 37	HUT 37	HUY 38	NEW HTWD 38	NEW HUTT 38
					
HBU 39	HCJB 39	HLJB 39	HPP 40	HPF 40	HRPL-N 40
					
HRPT-N 40	HRST-N 41	HRWT-N 41	HUFF 41		

## Index

### Check Valves



HCVU  
43



HCVU  
43

### Hand Valves



HBVU  
44



HBVU  
44



HBVL-R  
45



NEW HESV  
45



NEW HASV  
45

### Valved Barb Connector



HCVB  
46

### Flow Regulators



HSLB  
50



HSLB  
50



HSTB  
50



HSTB  
50



HSLU  
51



HSLU  
51



HSTU  
51



HSTU  
51

### Filters



HBMU  
52



HBMU  
52



HFS  
53

## Index

---

### Cartridges



HCAS-P  
54



HCAS-H  
55



HCAS-F  
55



HOR  
56

---

### Steelfit Fittings



HUCP  
60



HULP  
60



HULS  
60

---

### Accessories



HCP  
61



HRT  
61



ETC  
62



HBC  
62

---

### Tubes

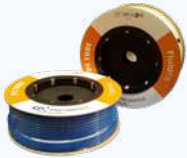

PE  
63



**NEW**

# Fluidfit

## DISPENSING ITEMS



**W270 KTW**



NSF51  
NSF61



HCF-G-H  
32



HBUJ  
36



HTWD  
38



HUTT  
38



HESV  
45



HASV  
45

# Metric Fittings



## Male connector BSPT - Diritto maschio BSPT

### HPC-R

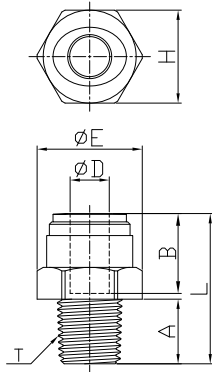

NEW

CODE	ØD	T (BSPT)	A	B	ØE	H	L	WEIGHT (G)	
HPC04R01B	4	R 1/8	9,1	14,7	18,5	17	26,0	4,1	100
HPC06R01B	6	R 1/8	9,1	16,1	18,5	17	26,2	3,9	100
HPC06R02B	6	R 1/4	13,1	16,1	18,5	17	26,7	4,2	100
HPC06R03B	6	R 3/8	13,5	16,1	21,0	19	26,6	5,9	50
HPC06R04B	6	R 1/2	16,3	16,1	24,4	22	29,7	9,1	50
HPC08R01B	8	R 1/8	9,1	17,5	21,0	19	28,1	5,2	100
HPC08R02B	8	R 1/4	13,1	17,5	21,0	19	30,6	5,8	50
HPC08R03B	8	R 3/8	13,5	17,5	21,0	19	27,0	5,7	50
HPC10R02B	10	R 1/4	13,1	20,1	21,0	19	36,0	7,7	50
HPC10R03B	10	R 3/8	13,5	20,1	23,2	21	28,8	6,7	50
HPC10R04B	10	R 1/2	16,3	20,1	24,4	22	32,1	9,6	50
HPC12R03B	12	R 3/8	13,5	24,7	26,5	24	32,2	8,9	50
HPC12R04B	12	R 1/2	16,3	24,7	26,5	24	34,3	11,0	50

## Male connector BSPP - Diritto maschio BSPP

### HPC-G

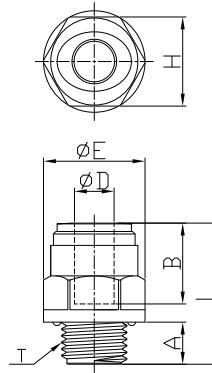

CODE	ØD	T (BSPP)	A	B	ØE	H	L	WEIGHT (G)	
HPC04G01B	4	G 1/8	6,0	14,7	16,6	15	21,9	3,3	100
HPC04G02B	4	G 1/4	8,5	14,7	20,5	18	23,9	4,9	100
HPC06G01B	6	G 1/8	6,0	16,1	16,6	15	24,1	3,3	100
HPC06G02B	6	G 1/4	8,5	16,1	20,5	18	24,1	4,8	100
HPC08G01B	8	G 1/8	6,0	17,5	18,5	17	27,0	5,2	100
HPC08G02B	8	G 1/4	8,5	17,5	20,5	18	28,5	6,1	50
HPC08G03B	8	G 3/8	9,0	17,5	24,0	21	26,5	7,0	50
HPC08G04B	8	G 1/2	12,5	17,5	28,5	26	29,5	11,9	50
HPC10G02B	10	G 1/4	8,5	20,1	21,1	19	30,8	7,2	50
HPC10G03B	10	G 3/8	9,0	20,1	24,2	21	26,3	7,0	50
HPC10G04B	10	G 1/2	12,5	20,1	28,5	26	29,8	11,3	25
HPC12G03B	12	G 3/8	9,0	24,7	27,0	24	34,2	11,6	25
HPC12G04B	12	G 1/2	12,5	24,7	28,5	26	32,7	12,4	25
HPC15G04B	15	G 1/2	12,5	29,4	28,8	26	43,4	17,0	25
HPC15G06B	15	G 3/4	14,5	29,4	39,0	33	39,0	24,5	20
HPC22G06B	22	G 3/4	14,5	33,8	37,0	33	51,0	28,2	20

## Male connector NPTF - Diritto maschio NPTF

### HPC-N

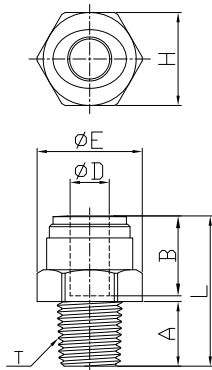

NEW

CODE	ØD	T (NPTF)	A	B	ØE	H	L	WEIGHT (G)	
HPC06-N03B	6	N 3/8	13,8	16,9	21,4	19,0	26,1	6,3	50
HPC12-N04B	12	N 1/2	17,8	24,9	27,4	24,5	37,7	13,0	50

# Metric Fittings



Female adapter BSPP with internal flat gasket - Diritto femmina BSPP con guarnizione piana interna

## HCF-G

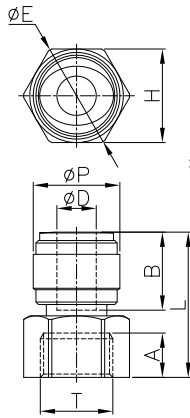

\* brass thread  
filetto in ottone

\* NEW

NEW

\*

CODE	ØD	T (BSPP)	ØP	L	A	B	H	ØE	WEIGHT (G)	
HCF04G01B	4	G 1/8	17,6	26,9	6,0	14,7	17	19,2	6,6	50
HCF06G01B	6	G 1/8	17,6	27,1	6,0	16,1	17	19,2	6,1	50
HCF06G02B	6	G 1/4	17,6	29,1	8,5	16,1	19	21,5	7,0	50
HCF06G03B	6	G 3/8	15,0	29,6	9,0	16,1	24	27,3	8,9	50
* NEW HCF06G06B	6	G 3/4	15,5	34,2	7,0	16,1	36,7	41,6	37,6	20
HCF08G01B	8	G 1/8	17,6	27,5	6,0	17,5	17	19,2	6,0	50
HCF08G02B	8	G 1/4	17,6	29,5	8,5	17,5	19	21,5	6,7	50
HCF08G03B	8	G 3/8	17,6	31,0	9,0	17,5	24	27,3	9,7	50
HCF08G04B	8	G 1/2	20,0	38,0	12,5	17,5	27	30,0	13,8	25
* HCF08G06B	8	G 3/4	20,0	36,6	10,0	17,5	36,7	41,6	39,2	20
HCF10G02B	10	G 1/4	23,0	34,5	8,5	20,1	19	21,5	10,8	50
HCF10G03B	10	G 3/8	23,0	37,0	9,0	20,1	24	27,3	13,7	25
HCF10G04B	10	G 1/2	20,0	38,3	12,5	20,1	27	30,0	13,3	25
NEW HCF10G05B	10	G 5/8	20,0	38,1	13,5	20,1	29	32,0	14,8	25
* HCF10G06B	10	G 3/4	20,0	36,9	10,0	20,1	36,7	41,6	38,6	20
HCF12G02B	12	G 1/4	23,0	35,2	8,5	24,7	19	21,5	10,3	50
HCF12G03B	12	G 3/8	23,0	37,7	9,0	24,7	24	27,3	13,0	25
HCF12G04B	12	G 1/2	23,0	41,7	12,5	24,7	27	30,0	15,4	25
HCF15G04B	15	G 1/2	28,0	46,2	12,5	29,4	27	30,0	20,1	20
HCF15G06B	15	G 3/4	28,0	45,4	12,0	29,4	33	37,0	25,1	20

HCF15G06B: single plastic bag

Female adapter UNF - Diritto femmina UNF

## HCF-UNF

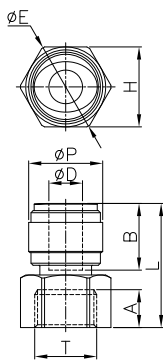

CODE	ØD	T (UNF)	ØP	L	A	B	H	ØE	WEIGHT (G)	
HCF06-UNF7/16-20B	6	7/16-20	17,6	30,1	9,5	16,1	17	19	6,5	50
HCF08-UNF7/16-20B	8	7/16-20	17,6	30,5	9,5	17,5	17	19	6,5	50
HCF10-UNF7/16-20B	10	7/16-20	20,0	33,1	9,5	20,1	17	19	7,5	50

# Metric Fittings



Female adapter UNS with internal flat gasket - Diritto femmina UNS con guarnizione piana interna

## HCF-UNS

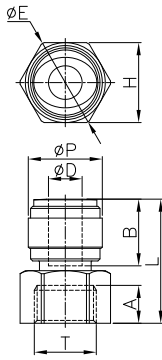

CODE	ØD	T (UNS)	ØP	L	A	B	H	ØE	WEIGHT (G)	
HCF06-UNS7/16-24B	6	7/16-24	17,6	27,1	6,7	16,1	17	19	6,1	50
HCF08-UNS7/16-24B	8	7/16-24	17,6	27,5	6,7	17,5	17	19	6,1	50

Female adapter NH with internal flat gasket - Diritto femmina NH con guarnizione piana interna

## HCF-NH



brass thread  
filetto in ottone

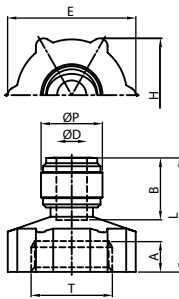

CODE	ØD	T (NH)	ØP	L	A	B	H	ØE	WEIGHT (G)	
HCF06-NH06B	6	3/4	15,5	34,2	10,0	16,1	36,7	41,6	34,9	20
HCF08-NH06B	8	3/4	20,0	36,6	10,0	17,5	36,7	41,6	36,5	20
HCF10-NH06B	10	3/4	20,0	36,9	10,0	20,1	36,7	41,6	38,1	20

Male elbow BSPT - Gomito maschio BSPT

## HPL-R

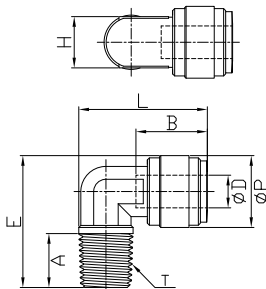

CODE	ØD	T (BSPT)	ØP	A	B	E	H	L	WEIGHT (G)	
HPL04R01B	4	R 1/8	15,0	9,1	14,7	25,6	10	25,2	4,2	100
HPL04R02B	4	R 1/4	15,0	13,1	14,0	30,6	10	26,8	5,6	50
HPL06R01B	6	R 1/8	15,0	9,1	16,1	25,6	10	25,4	4,1	100
HPL06R02B	6	R 1/4	15,0	13,1	16,1	30,6	10	27,0	5,1	50
HPL06R03B	6	R 3/8	17,6	13,5	16,1	32,6	13	33,1	8,4	50
HPL08R02B	8	R 1/4	17,6	13,1	17,5	32,2	13	31,5	7,0	50
HPL08R03B	8	R 3/8	17,6	13,5	17,5	32,6	13	33,5	8,0	50
HPL10R02B	10	R 1/4	20,0	13,1	20,1	34,1	14	32,0	8,1	25
HPL10R03B	10	R 3/8	20,0	13,5	20,1	35,7	14	33,9	9,2	50
HPL12R02B	12	R 1/4	23,6	13,1	24,7	38,3	17	38,2	13,1	25
HPL12R03B	12	R 3/8	23,0	13,5	24,7	38,3	17,0	38,4	13,2	25
HPL12R04B	12	R 1/2	23,0	16,3	24,7	41,4	17,7	40,7	15,6	25

# Metric Fittings



Male elbow NPTF - Gomito maschio NPTF

## HPL-N

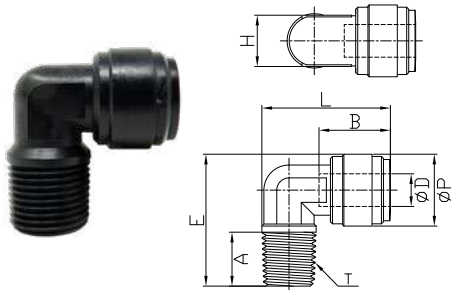

CODE	ØD	T (NPTF)	ØP	A	B	E	H	L	WEIGHT (G)	☐
HPL06N03B	6	N 3/8	15,5	13,8	16,1	32,8	11	28,9	7,4	50
HPL12N04B	12	N 1/2	23,6	17,8	24,7	43,3	17,4	41,3	16,7	25

Bulkhead connector with gasket - Passaparete con guarnizione

## HMM

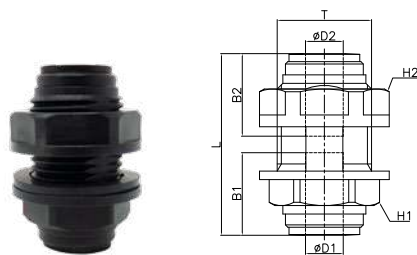

CODE	ØD1	ØD2	T	L	B1	B2	H1 (Fixed)	H2	WEIGHT (G)	☐
HMM0404B	4	4	M15x1,5p	32,4	14,7	14,7	17	18	6,9	50
HMM0606B	6	6	M17x1,5p	35,7	16,1	16,1	19	21	9,6	50
HMM0808B	8	8	M20x1,75p	38,5	17,5	17,5	21	25,5	14,0	25
HMM1010B	10	10	M24x1,75p	42,2	20,1	20,1	24	28,5	19,5	25
HMM1212B	12	12	M27x2,0p	51,4	24,7	24,7	27	31	28,2	20

CODE	ØD1	ØD2	T	L	B1	B2	H1 (Fixed)	H2	WEIGHT (G)	☐
HMM0604B	6	4	M17x1,5p	35,5	16,1	16,1	19	21	9,8	50
HMM0806B	8	6	M20x1,75p	38,1	17,5	17,5	21	25,5	14,3	25

Reducer - Riduzione

## HGJ

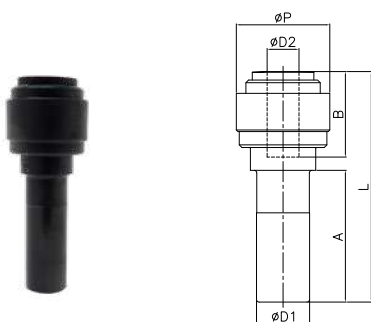

CODE	ØD1	ØD2	ØP	L	A	B	WEIGHT (G)	☐
HGJ0604B	6	4	13,2	36,7	21,0	14,7	2,4	100
HGJ0804B	8	4	15,5	40,4	22,5	14,7	3,7	100
HGJ0806B	8	6	15,5	40,6	22,5	16,1	3,5	100
HGJ1006B	10	6	17,6	43,4	24,8	16,1	5,2	50
HGJ1008B	10	8	17,6	43,8	24,8	17,5	5,1	50
HGJ1208B	12	8	20,0	51,3	29,5	17,5	7,3	50
HGJ1210B	12	10	20,0	51,6	29,5	20,1	6,9	50
HGJ1510B	15	10	20,0	61,0	35,0	20,1	12,0	25
HGJ1512B	15	12	23,6	61,7	35,0	24,7	11,3	25
HGJ2215B	22	15	28,0	70,4	41,0	29,4	19,7	20

HGJ2215B: single plastic bag

Enlarger - Maggiorazione

CODE	ØD1	ØD2	ØP	L	A	B	WEIGHT (G)	☐
HGJ0405B	4	5	13,8	35,0	18,0	15,0	2,4	100
HGJ0810B	8	10	20,0	44,9	22,5	20,1	5,4	50

# Metric Fittings



Male stem adapter BSPT - Adattatore a codolo maschio BSPT

## H CJ-R

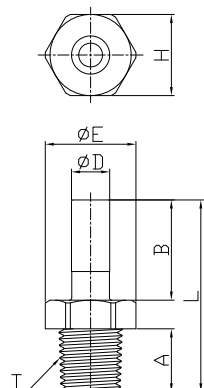

CODE	ØD	T (BSPT)	A	B	ØE	H	L	WEIGHT (G)	☐
H CJ04R01B	4	R 1/8	9,1	18,0	14,4	13	33,1	1,8	100
H CJ04R02B	4	R 1/4	13,1	18,0	18,5	17	37,1	3,5	100
H CJ06R01B	6	R 1/8	9,1	19,5	14,4	13	34,6	2,0	100
H CJ06R02B	6	R 1/4	13,1	19,5	18,5	17	38,6	3,7	100
H CJ08R01B	8	R 1/8	9,1	21,0	14,4	13	36,1	2,2	100
H CJ08R02B	8	R 1/4	13,1	21,0	18,5	17	40,1	3,8	50
H CJ08R03B	8	R 3/8	13,5	21,0	23,0	21	40,5	5,3	50
H CJ10R02B	10	R 1/4	13,1	24,0	18,5	17	43,1	4,5	50
H CJ10R03B	10	R 3/8	13,5	24,0	23,0	21	44,0	6,1	50
H CJ10R04B	10	R 1/2	16,5	24,0	26,5	24	47,0	9,7	25
H CJ12R03B	12	R 3/8	13,5	28,0	23,0	21	48,0	6,8	50
H CJ12R04B	12	R 1/2	16,5	28,0	26,5	24	51,0	10,2	25

Male stem adapter BSPP - Adattatore a codolo maschio BSPP

## H CJ-G

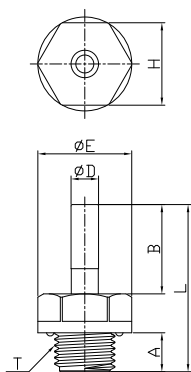

CODE	ØD	T (BSPP)	A	B	ØE	H	L	WEIGHT (G)	☐
H CJ04G01B	4	G 1/8	6,0	18,0	16,6	15	32,5	2,7	100
H CJ04G02B	4	G 1/4	8,5	18,0	20,5	18	35,0	4,2	100
H CJ06G01B	6	G 1/8	6,0	19,5	16,6	15	34,0	2,8	100
H CJ06G02B	6	G 1/4	8,5	19,5	20,5	18	36,5	4,3	100
H CJ08G01B	8	G 1/8	6,0	21,0	16,6	15	35,5	3,0	100
H CJ08G02B	8	G 1/4	8,5	21,0	20,5	18	38,0	4,6	50
H CJ08G03B	8	G 3/8	9,0	21,0	24,2	22	38,5	6,2	50
H CJ10G02B	10	G 1/4	8,5	24,0	20,5	18	41,0	5,2	50
H CJ10G03B	10	G 3/8	9,0	24,0	24,2	22	41,5	6,8	50
H CJ10G04B	10	G 1/2	12,5	24,0	28,5	26	45,0	10,7	25
H CJ12G03B	12	G 3/8	9,0	28,0	24,2	22	45,5	7,3	50
H CJ12G04B	12	G 1/2	12,5	28,0	28,5	26	49,0	11,2	25
H CJ15G03B	15	G 3/8	9,0	35,0	24,2	22,0	52,5	9,5	50
H CJ15G04B	15	G 1/2	12,5	36,0	28,8	26	57,0	13,1	25
H CJ22G04B	22	G 1/2	12,5	41,0	28,4	26	62,0	16,8	20
H CJ22G06B	22	G 3/4	14,5	41,0	39,0	33	67,5	25,8	20

H CJ22G06B: single plastic bag

# Metric Fittings



## Union elbow tube with stem - Gomito con codolo

### HLJ

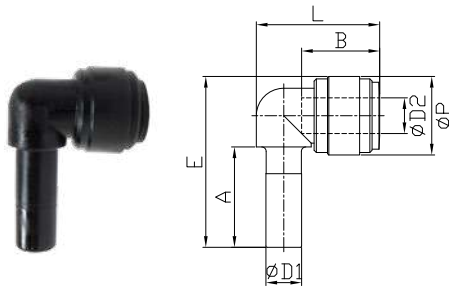

CODE	ØD1	ØD2	ØP	A	B	E	L	WEIGHT (G)	
HLJ0404B	4	4	13,2	18,0	14,7	30,1	21,9	2,5	100
HLJ0606B	6	6	15,5	21,0	16,1	34,8	25,1	3,7	100
HLJ0808B	8	8	17,6	22,5	17,5	38,3	27,7	5,3	50
HLJ1010B	10	10	20,0	24,8	20,1	43,2	31,3	7,4	50
HLJ1212B	12	12	23,6	29,5	24,7	51,2	39,0	12,6	25
HLJ1515B	15	15	28,0	35,0	29,4	61,3	48,5	21,7	20
HLJ2222B	22	22	35,5	41,0	33,8	75,5	58,0	38,9	20

HLJ2222B: single plastic bag

## Reduction - Riduzione

CODE	ØD1	ØD2	ØP	A	B	E	L	WEIGHT (G)	
HLJ1006B	10	6	20,0	24,8	16,1	43,2	30,6	7,8	50
HLJ1008B	10	8	20,0	24,8	17,5	43,2	31,0	8,2	50

## Enlarger - Maggiorazione

CODE	ØD1	ØD2	ØP	A	B	E	L	WEIGHT (G)	
HLJ0608B	6	8	17,6	21,0	17,5	36,8	26,0	4,7	100

## Run male tee with stem - T laterale con codolo

### HSJ

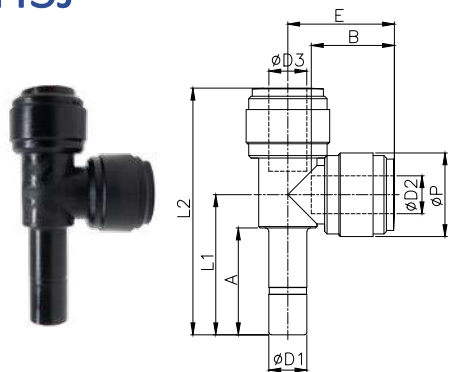

CODE	ØD1	ØD2	ØD3	ØP	A	B	E	L1	L2	WEIGHT (G)	
HSJ0404B	4	4	4	13,2	18,0	14,7	17,7	23,5	41,2	4,5	100
HSJ0606B	6	6	6	15,0	21,0	16,1	20,1	27,0	47,1	5,9	50
HSJ0808B	8	8	8	17,6	22,5	17,5	22,5	29,5	52,0	9,1	50
HSJ1010B	10	10	10	20,0	24,8	20,1	26,1	33,2	59,3	12,5	25
HSJ1212B	12	12	12	23,0	29,5	24,7	31,7	39,4	71,1	19,6	20

## Barb connector - Portagomma

### HCBB



CODE	ØD1	ØD2	BARB	ØP	L	A	B	WEIGHT (G)	
HCBB1210B	12	10	10,0	23,0	46,9	20,0	24,7	8,5	25
HCBB15-1/2B	15	1/2	13,3	28,0	54,2	22,3	29,4	14,0	20
HCBB22-1/2B	22	1/2	13,3	35,7	58,8	22,3	33,8	22,1	20
HCBB22-3/4B	22	3/4	20,25	35,7	66,5	30,0	33,8	25,7	20

# Metric Fittings



Union connector - Intermedio diritto

## HUC

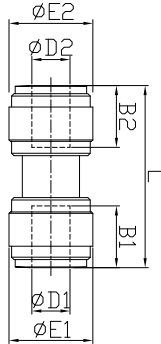

CODE	ØD1	ØD2	B1	B2	ØE1	ØE2	L	WEIGHT (G)	
HUC0404B	4	4	14,7	14,7	13,2	13,2	31,8	3,8	100
HUC0606B	6	6	16,1	16,1	15,0	15,0	35,2	4,7	100
HUC0808B	8	8	17,5	17,5	17,6	17,6	38,2	6,9	50
HUC1010B	10	10	20,1	20,1	20,0	20,0	42,7	9,2	50
HUC1212B	12	12	24,7	24,7	23,0	23,0	52,4	14,4	25
HUC1515B	15	15	29,4	29,4	28,0	28,0	61,8	23,4	20
HUC2222B	22	22	33,8	33,8	35,5	35,5	70,6	37,7	9

CODE	ØD1	ØD2	B1	B2	ØE1	ØE2	L	WEIGHT (G)	
HUC0604B	6	4	16,1	14,7	15,0	15,0	35,0	5,0	100
HUC0605B	6	5	16,1	14,9	15,0	15,0	35,1	4,9	100
HUC0804B	8	4	17,5	14,7	17,6	17,6	36,6	6,5	50
HUC0806B	8	6	17,5	16,1	17,6	17,6	37,8	7,1	50
HUC1006B	10	6	20,1	16,1	20,0	15,5	42,0	9,8	50
HUC1008B	10	8	20,1	17,5	20,0	20,0	42,4	9,6	50
HUC1208B	12	8	24,7	17,5	23,6	17,6	44,4	11,5	25
HUC1210B	12	10	24,7	20,1	23,0	23,0	51,7	15,0	25

Union elbow 45° - Intermedio a gomito a 45°

## HUGL

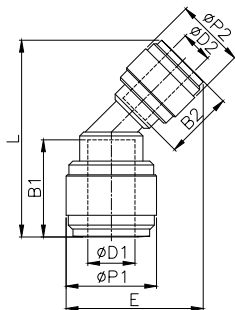

NEW

CODE	ØD1	ØD2	B1	B2	ØP1	ØP2	L	E	WEIGHT (G)	
HUGL1208B	12	8	24,7	17,5	23,0	17,6	50,1	34,9	11,3	25



# Metric Fittings



Union elbow - Intermedio a gomito

## HUL

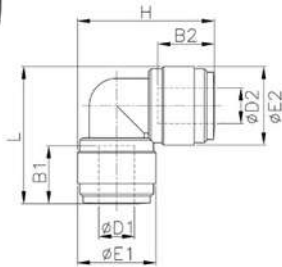

Hybrid solution metric + inch  
Soluzione ibrida metrico + pollici

CODE	ØD1	ØD2	B1	B2	ØE1	ØE2	L	H	WEIGHT (G)	
HUL0404B	4	4	14,7	14,7	13,2	13,2	24,5	24,5	3,9	100
HUL0606B	6	6	16,1	16,1	15,0	15,0	27,6	27,6	5,1	100
HUL0808B	8	8	17,5	17,5	17,6	17,6	30,7	30,7	7,6	50
HUL1010B	10	10	20,1	20,1	20,0	20,0	35,8	35,8	10,2	50
HUL1212B	12	12	24,7	24,7	23,0	23,0	43,2	43,2	16,4	25
HUL1515B	15	15	29,4	29,4	28,0	28,0	52,2	52,2	27,4	20
HUL2222B	22	22	33,8	33,8	35,5	35,5	63,9	63,9	46,8	9

CODE	ØD1	ØD2	B1	B2	ØE1	ØE2	L	H	WEIGHT (G)	
HUL0804B	8	4	17,5	14,7	17,6	13,2	28,3	29,7	5,9	50
HUL0806B	8	6	17,5	16,1	17,6	17,6	30,7	30,3	7,7	50
HUL1006B	10	6	20,1	16,1	23,0	17,6	37,8	36,1	12,6	50
HUL1008B	10	8	20,1	17,5	20,0	20,0	35,8	35,5	10,2	50
HUL1206B	12	6	24,7	16,1	23,0	17,6	38,5	36,1	12,0	50
HUL1208B	12	8	24,7	17,5	23,0	17,6	38,5	36,5	11,9	50
HUL1210B	12	10	24,7	20,1	23,0	23,0	43,2	42,5	17,3	25

CODE	ØD1	ØD2	B1	B2	ØE1	ØE2	L	H	WEIGHT (G)	
HUL1/4-06B	1/4	6	16,9	16,1	15,5	15,5	28,75	28,75	6,0	100

Union tee - Intermedio a T

## HUT

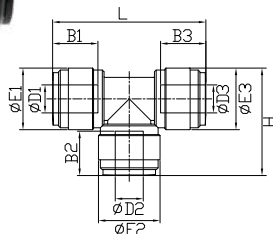

CODE	ØD1	ØD2	ØD3	B1	B2	B3	ØE1	ØE2	ØE3	H	L	WEIGHT (G)	
HUT0404B	4	4	4	14,7	14,7	14,7	13,2	13,2	13,2	24,5	35,8	5,8	100
HUT0606B	6	6	6	16,1	16,1	16,1	15,0	15,0	15,0	27,6	40,2	7,3	50
HUT0808B	8	8	8	17,5	17,5	17,5	17,6	17,6	17,6	30,7	43,8	10,6	50
HUT1010B	10	10	10	20,1	20,1	20,1	20,0	20,0	20,0	35,8	51,6	14,6	25
HUT1212B	12	12	12	24,7	24,7	24,7	23,0	23,0	23,0	43,2	63,4	23,2	20
HUT1515B	15	15	15	29,4	29,4	29,4	28,0	28,0	28,0	52,2	76,4	38,2	9
HUT2222B	22	22	22	33,8	33,8	33,8	35,5	35,5	35,5	63,9	92,3	64,0	6

CODE	ØD1	ØD2	ØD3	B1	B2	B3	ØE1	ØE2	ØE3	H	L	WEIGHT (G)	
HUT100806B	10	8	6	20,1	16,1	17,5	20,0	15,0	20,0	32,1	48,6	15,6	25
HUT100608B	10	6	8	20,1	16,1	17,5	20,0	15,0	20,0	32,1	48,6	15,6	25
HUT100610B	10	6	10	20,1	16,1	20,1	20,0	15,0	20,0	32,1	48,7	12,0	25
HUT121012B	12	10	12	24,7	20,1	24,7	23,0	23,0	23,0	42,5	63,4	24,2	20
HUT221222B	22	12	22	33,8	24,7	33,8	35,5	23,0	35,5	55,8	83,0	50,3	6
HUT221522B	22	15	22	33,8	30,4	33,8	35,5	28,0	35,5	61,0	87,0	57,1	6

# Metric Fittings



Union Y - Intermedio a Y

## HUY

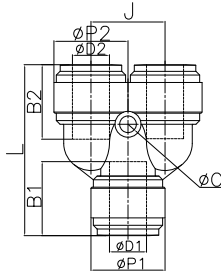

CODE	ØD1	ØD2	B1	B2	ØP1	ØP2	L	J	ØC	WEIGHT (G)	
HUY0404B	4	4	14,7	14,7	13,8	13,8	33,7	13,5	3,3	6,7	100
HUY0606B	6	6	16,1	16,1	15,5	15,5	38,8	15,5	3,3	9,2	50
HUY0808B	8	8	17,5	17,5	17,6	17,6	41,0	17,6	4,5	11,6	50
HUY1010B	10	10	20,1	20,1	20,0	20,0	46,2	20,0	4,5	16,0	25
HUY1212B	12	12	24,7	24,7	23,0	23,0	56,4	23,0	4,5	26,3	20

CODE	ØD1	ØD2	B1	B2	ØP1	ØP2	L	J	ØC	WEIGHT (G)	
HUY1008B	10	8	20,1	17,5	20,0	20,0	45,9	20,0	4,5	16,8	25

Cross junction - Intermedio a croce

## HZA

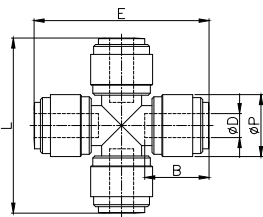

CODE	ØD	ØP	L	E	B	WEIGHT (G)	
HZA0606B	6	15,5	43,8	43,8	16,1	9,7	25
HZA0808B	8	17,6	47,3	47,3	17,5	15,0	20

Tube barb connector - Codolo portagomma diritto

## HCJB

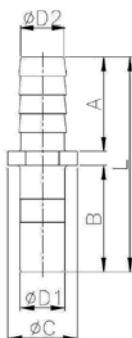

CODE	ØD1	ØD2	BARB	ØC	L	A	B	WEIGHT (G)	
HCJB0604B	6	4	4,5	11,4	38,2	18,0	17,2	1,0	100
HCJB0606B	6	6	6,5	11,4	38,2	18,0	17,2	1,1	100
HCJB0806B	8	6	6,5	12,2	40,0	18,0	19,0	1,7	100
HCJB1006B	10	6	6,5	14,7	43,5	18,0	22,5	2,3	100
HCJB1008B	10	8	8,6	14,7	43,5	18,0	22,5	2,7	100
HCJB1010B	10	10	10,6	14,7	45,5	20,0	22,5	3,0	100
HCJB1210B	12	10	10,6	18,5	50,5	20,0	27,5	4,3	100

# Metric Fittings



Elbow tube barb connector - Codolo portagomma a gomito

## HLJB

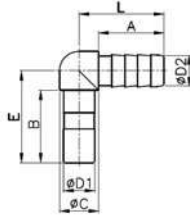

CODE	ØD1	ØD2	BARB	ØC	L	E	A	B	WEIGHT (G)	
HLJB1006B	10	6	6,5	12,0	24,0	28,5	18,0	22,5	3,0	100
HLJB1008B	10	8	8,6	12,0	24,0	28,5	18,0	22,5	3,4	100

Male plug - Tappo maschio

## HPP

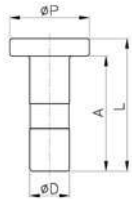

CODE	ØD	ØP	L	A	WEIGHT (G)	
HPP04B	4	13	22,5	19,0	0,8	200
HPP06B	6	13	24,5	21,0	1,1	200
HPP08B	8	16	26,5	23,0	1,8	100
HPP10B	10	18	30,0	26,0	2,7	100
HPP12B	12	21	34,0	30,0	4,0	100
HPP15B	15	25	40,0	36,0	6,4	50
HPP22B	22	33	45,5	41,0	12,2	25

Female plug - Tappo femmina

## HPF

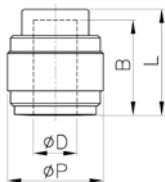

NEW

CODE	ØD	ØP	L	B	WEIGHT (G)	
HPF04B	4	13,2	16,9	14,7	2,0	100
HPF06B	6	15,5	18,9	16,1	2,8	100
HPF08B	8	17,6	19,5	17,5	3,6	100
HPF10B	10	20,0	22,1	20,1	4,7	100
HPF12B	12	23,0	26,7	24,7	7,3	50
HPF15B	15	28,0	32,1	29,4	12,6	50
HPF22B	22	35,5	36,6	33,8	20,6	20

# Metric Fittings



Male swivel elbow BSPT - Gomito girevole maschio conico BSPT

## HRPL-R

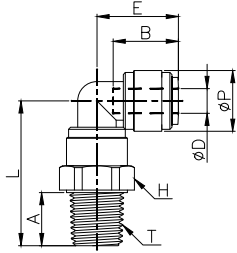

CODE	ØD	T (BSPT)	ØP	A	B	E	H	L	WEIGHT (G)	
HRPL04R01B	4	R 1/8	13.2	9.1	14.7	17.9	15	29,7	5,9	50
HRPL04R02B	4	R 1/4	13.2	13.1	14.7	17.9	17	33,7	7,3	50
HRPL06R01B	6	R 1/8	15.0	9.1	16.1	20.1	17	31,7	7,2	50
HRPL06R02B	6	R 1/4	15.0	13.1	16.1	20.1	17	35,7	8,0	50
HRPL08R01B	8	R 1/8	17.6	9.1	17.5	21.9	19	33,4	9,9	25
HRPL08R02B	8	R 1/4	17.6	13.1	17.5	21.9	19	37,4	10,7	25
HRPL08R03B	8	R 3/8	17.6	13.5	17.5	21.9	19	37,8	11,4	25
HRPL10R02B	10	R 1/4	20.0	13.1	20.1	25.8	21	41,4	15,1	25
HRPL10R03B	10	R 3/8	20.0	13.5	20.1	25.8	21	41,8	15,2	25
HRPL10R04B	10	R 1/2	20.0	16.5	20.1	25.8	24	44,8	19,5	20
HRPL12R03B	12	R 3/8	23.0	13.5	24.7	31.7	24	48,2	23,4	20
HRPL12R04B	12	R 1/2	23.0	16.5	24.7	31.7	24	51,2	25,9	20

Male swivel elbow BSPP - Gomito girevole maschio cilindrico BSPP

## HRPL-G

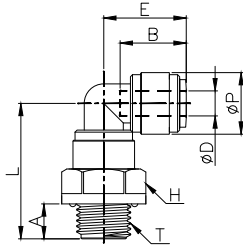

CODE	ØD	T (BSPP)	ØP	A	B	E	H	L	WEIGHT (G)	
HRPL04G01B	4	G 1/8	13,2	6,0	14,7	17,9	15,0	28,5	6,0	50
HRPL04G02B	4	G 1/4	13,2	8,5	14,7	17,9	18,0	31,0	7,7	50
HRPL06G01B	6	G 1/8	15,0	6,0	16,1	20,1	17,0	30,5	7,7	50
HRPL06G02B	6	G 1/4	15,0	8,5	16,1	20,1	18,0	33,0	8,7	50
HRPL08G01B	8	G 1/8	17,6	6,0	17,5	21,9	18,0	31,9	10,4	25
HRPL08G02B	8	G 1/4	17,6	8,5	17,5	21,9	18,0	34,4	11,0	25
HRPL08G03B	8	G 3/8	17,6	9,0	17,5	21,9	22,0	34,9	12,8	25
HRPL10G02B	10	G 1/4	20,0	8,5	20,1	25,8	22,0	38,0	15,4	25
HRPL10G03B	10	G 3/8	20,0	9,0	20,1	25,8	22,0	38,5	15,8	25
HRPL10G04B	10	G 1/2	20,0	12,5	20,1	25,8	26,0	42,0	19,1	20
HRPL12G03B	12	G 3/8	23,0	9,0	24,7	31,7	26,0	43,7	23,2	20
HRPL12G04B	12	G 1/2	23,0	12,5	24,7	31,7	26,0	47,2	25,2	20

Male swivel tee BSPT - T girevole maschio conico BSPT

## HRPT-R

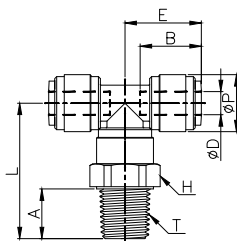

CODE	ØD	T (BSPT)	ØP	A	B	E	H	L	WEIGHT (G)	
HRPT04R01B	4	R 1/8	13,2	9,1	14,7	17,9	15,0	29,7	7,8	50
HRPT04R02B	4	R 1/4	13,2	13,1	14,7	17,9	17,0	33,7	9,2	50
HRPT06R01B	6	R 1/8	15,0	9,1	16,1	20,1	17,0	31,7	9,3	50
HRPT06R02B	6	R 1/4	15,0	13,1	16,1	20,1	17,0	35,7	10,3	25
HRPT08R01B	8	R 1/8	17,6	9,1	17,5	21,9	19,0	33,4	13,1	25
HRPT08R02B	8	R 1/4	17,6	13,1	17,5	21,9	19,0	37,4	14,0	25
HRPT08R03B	8	R 3/8	17,6	13,5	17,5	21,9	19,0	37,8	14,6	25
HRPT10R02B	10	R 1/4	20,0	13,1	20,1	25,8	21,0	41,4	19,5	25
HRPT10R03B	10	R 3/8	20,0	13,5	20,1	25,8	21,0	41,8	19,6	20
HRPT10R04B	10	R 1/2	20,0	16,5	20,1	25,8	24,0	44,8	23,9	20
HRPT12R03B	12	R 3/8	23,0	13,5	24,7	31,7	24,0	42,8	30,2	15
HRPT12R04B	12	R 1/2	23,0	16,5	24,7	31,7	24,0	51,2	32,7	12

# Metric Fittings



Swivel male tee BSPP - T girevole maschio cilindrico BSPP

## HRPT-G

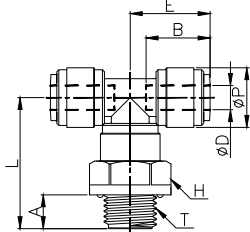

CODE	ØD	T (BSPP)	ØP	A	B	E	H	L	WEIGHT (G)	
HRPT04G01B	4	G 1/8	13,2	6,0	14,7	17,9	15	28,5	7,9	50
HRPT04G02B	4	G 1/4	13,2	8,5	14,7	17,9	18	31,0	9,6	50
HRPT06G01B	6	G 1/8	15,0	6,0	16,1	20,1	17	30,5	10,0	50
HRPT06G02B	6	G 1/4	15,0	8,5	16,1	20,1	18	33,0	11,0	25
HRPT08G01B	8	G 1/8	17,6	6,0	17,5	21,9	18	31,9	13,4	25
HRPT08G02B	8	G 1/4	17,6	8,5	17,5	21,9	18	34,4	14,0	25
HRPT08G03B	8	G 3/8	17,6	9,0	17,5	21,9	22	34,9	15,8	25
HRPT10G02B	10	G 1/4	20,0	8,5	20,1	25,8	22	38,0	19,8	25
HRPT10G03B	10	G 3/8	20,0	9,0	20,1	25,8	22	38,5	20,2	20
HRPT10G04B	10	G 1/2	20,0	12,5	20,1	25,8	26	42,0	23,5	20
HRPT12G03B	12	G 3/8	23,0	9,0	24,7	31,7	26	43,7	30,0	15
HRPT12G04B	12	G 1/2	23,0	12,5	24,7	31,7	26	47,2	32,0	12

Swivel run male tee BSPT - T laterale girevole maschio conico BSPT

## HRST-R

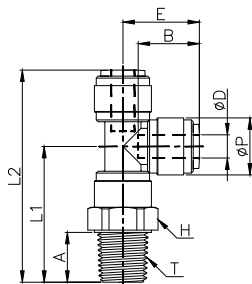

CODE	ØD	T (BSPT)	ØP	A	B	E	H	L1	L2	WEIGHT (G)	
HRST04R01B	4	R 1/8	13,2	9,1	14,7	17,9	15	29,7	47,6	7,8	50
HRST04R02B	4	R 1/4	13,2	13,1	14,7	17,9	17	33,7	51,6	9,2	50
HRST06R01B	6	R 1/8	15,0	9,1	16,1	20,1	17	31,7	51,8	9,3	50
HRST06R02B	6	R 1/4	15,0	13,1	16,1	20,1	17	35,7	55,8	10,3	25
HRST08R01B	8	R 1/8	17,6	9,1	17,5	21,9	19	33,4	55,3	13,1	25
HRST08R02B	8	R 1/4	17,6	13,1	17,5	21,9	19	37,4	59,3	14,0	25
HRST08R03B	8	R 3/8	17,6	13,5	17,5	21,9	19	37,8	59,7	14,6	25
HRST10R02B	10	R 1/4	20,0	13,1	20,1	25,8	21	41,4	67,2	19,5	25
HRST10R03B	10	R 3/8	20,0	13,5	20,1	25,8	21	41,8	67,6	19,6	20
HRST10R04B	10	R 1/2	20,0	16,5	20,1	25,8	24	44,8	70,6	23,9	20
HRST12R03B	12	R 3/8	23,0	13,5	24,7	31,7	24	48,2	79,9	30,2	15
HRST12R04B	12	R 1/2	23,0	16,5	24,7	31,7	24	51,2	82,9	32,7	12

Swivel run male tee BSPP - T laterale girevole maschio cilindrico BSPP

## HRST-G

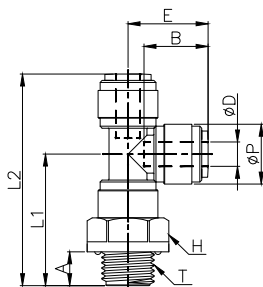

CODE	ØD	T (BSPP)	ØP	A	B	E	H	L1	L2	WEIGHT (G)	
HRST04G01B	4	G 1/8	13,2	6,0	14,7	17,9	15,0	28,5	46,4	7,9	50
HRST04G02B	4	G 1/4	13,2	8,5	14,7	17,9	18,0	31,0	48,9	9,6	50
HRST06G01B	6	G 1/8	15,0	6,0	16,1	20,1	17,0	30,5	50,6	10,0	50
HRST06G02B	6	G 1/4	15,0	8,5	16,1	20,1	18,0	33,0	53,1	11,0	25
HRST08G01B	8	G 1/8	17,6	6,0	17,5	21,9	18,0	31,9	53,8	13,4	25
HRST08G02B	8	G 1/4	17,6	8,5	17,5	21,9	18,0	34,4	56,3	14,0	25
HRST08G03B	8	G 3/8	17,6	9,0	17,5	21,9	22,0	34,9	56,8	15,8	25
HRST10G02B	10	G 1/4	20,0	8,5	20,1	25,8	22,0	38,0	63,8	19,8	25
HRST10G03B	10	G 3/8	20,0	9,0	20,1	25,8	22,0	38,5	64,3	20,2	20
HRST10G04B	10	G 1/2	20,0	12,5	20,1	25,8	26,0	42,0	67,8	23,5	20
HRST12G03B	12	G 3/8	23,0	9,0	24,7	31,7	26,0	43,7	75,4	30,0	15
HRST12G04B	12	G 1/2	23,0	12,5	24,7	31,7	26,0	47,2	78,9	32,0	12

# Metric Fittings



## Swivel male Y BSPT - Y girevole maschio conico BSPT

### HRWT-R

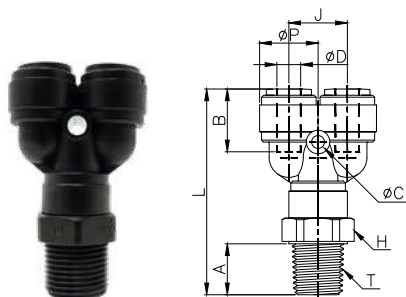

CODE	ØD	T (BSPT)	ØP	A	B	J	H	L	ØC	WEIGHT (G)	☐
HRWT04R01B	4	R 1/8	13,8	9,1	14,7	13,5	15,0	45,5	3,3	8,7	50
HRWT04R02B	4	R 1/4	13,8	13,1	14,7	13,5	17,0	49,5	3,3	10,1	50
HRWT06R01B	6	R 1/8	15,5	9,1	16,1	15,5	17,0	50,4	3,3	11,6	50
HRWT06R02B	6	R 1/4	15,5	13,1	16,1	15,5	17,0	54,4	3,3	12,5	25
HRWT08R01B	8	R 1/8	17,6	9,1	17,5	17,6	19,0	52,5	4,5	14,0	25
HRWT08R02B	8	R 1/4	17,6	13,1	17,5	17,6	19,0	56,5	4,5	14,9	25
HRWT08R03B	8	R 3/8	17,6	13,5	17,5	17,6	19,0	56,9	4,5	15,5	25
HRWT10R02B	10	R 1/4	20,0	13,1	20,1	20,0	21,0	61,8	4,5	20,9	25
HRWT10R03B	10	R 3/8	20,0	13,5	20,1	20,0	21,0	62,2	4,5	21,0	25
HRWT10R04B	10	R 1/2	20,0	16,5	20,1	20,0	24,0	65,2	4,5	25,3	20
HRWT12R03B	12	R 3/8	23,0	13,5	24,7	23,0	24,0	72,9	4,5	33,3	15
HRWT12R04B	12	R 1/2	23,0	16,5	24,7	23,0	24,0	75,9	4,5	35,8	12

## Swivel male Y BSPP - Y girevole maschio cilindrico BSPP

### HRWT-G

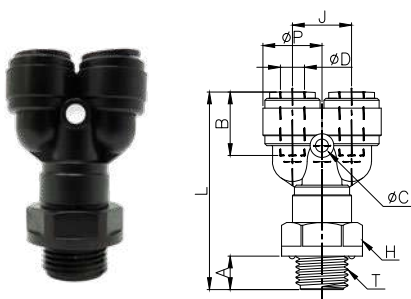

CODE	ØD	T (BSPP)	ØP	A	B	J	H	L	ØC	WEIGHT (G)	☐
HRWT04G01B	4	G 1/8	13,8	6,0	14,7	13,5	15,0	44,3	3,3	8,8	50
HRWT04G02B	4	G 1/4	13,8	8,5	14,7	13,5	18,0	46,8	3,3	10,5	50
HRWT06G01B	6	G 1/8	15,5	6,0	16,1	15,5	17,0	49,2	3,3	11,9	50
HRWT06G02B	6	G 1/4	15,5	8,5	16,1	15,5	18,0	51,7	3,3	12,9	25
HRWT08G01B	8	G 1/8	17,6	6,0	17,5	17,6	18,0	51,0	4,5	13,9	25
HRWT08G02B	8	G 1/4	17,6	8,5	17,5	17,6	18,0	53,5	4,5	15,1	25
HRWT08G03B	8	G 3/8	17,6	9,0	17,5	17,6	22,0	54,0	4,5	16,8	25
HRWT10G02B	10	G 1/4	20,0	8,5	20,1	20,0	22,0	58,4	4,5	21,2	25
HRWT10G03B	10	G 3/8	20,0	9,0	20,1	20,0	22,0	58,9	4,5	21,6	25
HRWT10G04B	10	G 1/2	20,0	12,5	20,1	20,0	26,0	62,4	4,5	24,9	20
HRWT12G03B	12	G 3/8	23,0	9,0	24,7	23,0	26,0	68,4	4,5	33,1	15
HRWT12G04B	12	G 1/2	23,0	12,5	24,7	23,0	26,0	71,9	4,5	35,1	12

## Threaded reducer BSPP with internal flat gasket - Riduzione filettata BSPP con guarnizione piana interna

### HUFF

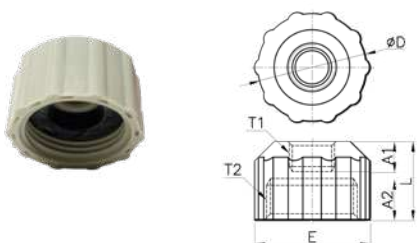

CODE	T1 (BSPP)	T2 (BSPP)	ØD	A1	A2	L	E	WEIGHT (G)	☐
HUFFG02-G06G	G 1/4	G 3/4	31,5	9,5	12,0	23,0	33,5	15,6	100
HUFFG03-G06G	G 3/8	G 3/4	31,5	9,5	12,0	23,0	33,5	14,5	100



# Inch Fittings



Male connector BSPT - Diritto maschio BSPT

## HPC-R

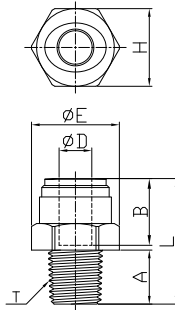

CODE	ØD	T (BSPT)	A	B	ØE	H	L	WEIGHT (G)	☐
HPC1/4-R01G	1/4	R 1/8	8,1	16,4	18,5	17	26,2	4,0	100
HPC1/4-R02G	1/4	R 1/4	12,2	16,1	18,5	17	26,8	3,2	100
HPC1/4-R03G	1/4	R 3/8	13,5	16,9	21,0	19	26,6	5,8	50
HPC3/8-R02G	3/8	R 1/4	13,1	20,2	21,0	19	36,1	7,8	50
HPC3/8-R03G	3/8	R 3/8	13,5	20,2	23,2	21	28,9	6,8	50

Male connector BSPP - Diritto maschio BSPP

## HPC-G

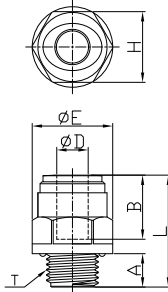

CODE	ØD	T (BSPP)	A	B	ØE	H	L	WEIGHT (G)	☐
HPC3/16-G01G	3/16	G 1/8	6,0	15,0	16,5	15,0	24,1	3,3	100
HPC1/4-G01G	1/4	G 1/8	6,0	16,9	16,5	15,0	24,1	3,6	100
HPC1/4-G02G	1/4	G 1/4	8,5	16,9	20,5	18,0	24,1	4,7	100
HPC5/16-G01G	5/16	G 1/8	6,0	17,5	18,5	17,0	27,0	5,2	100
HPC5/16-G02G	5/16	G 1/4	8,5	17,5	20,5	18,0	28,5	6,1	50
HPC5/16-G03G	5/16	G 3/8	9,0	17,5	24,0	21,0	26,5	7,0	50
HPC3/8-G02G	3/8	G 1/4	8,5	20,2	21,1	19,0	30,9	7,3	50
HPC3/8-G03G	3/8	G 3/8	8,5	20,2	24,2	21,0	26,4	7,1	50
HPC1/2-G03G	1/2	G 3/8	9,0	23,9	27,0	24,0	34,4	11,3	25
HPC1/2-G04G	1/2	G 1/2	12,5	24,9	28,4	26,0	32,9	12,3	25

Male connector NPTF - Diritto maschio NPTF

## HPC-N

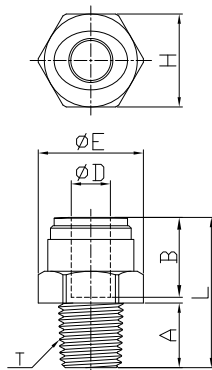

CODE	ØD	T (NPTF)	A	B	ØE	H	L	WEIGHT (G)	☐
HPC5/32-N01G	5/32	N 1/8	9,1	14,7	17,8	15,8 (5/8)	22,2	3,2	100
HPC5/32-N02G	5/32	N 1/4	13,2	14,7	17,8	15,8 (5/8)	25,3	4,3	100
HPC3/16-N01G	3/16	N 1/8	9,1	15,0	17,8	15,8 (5/8)	22,4	3,1	100
HPC3/16-N02G	3/16	N 1/4	13,2	15,0	17,8	15,8 (5/8)	25,5	4,2	100
HPC1/4-N01G	1/4	N 1/8	9,1	16,9	17,8	15,8 (5/8)	27,0	3,9	100
HPC1/4-N02G	1/4	N 1/4	13,2	16,9	17,8	15,8 (5/8)	27,0	4,3	100
HPC1/4-N03G	1/4	N 3/8	13,8	16,9	21,4	19,0 (3/4)	26,1	6,1	50
HPC1/4-N04G	1/4	N 1/2	17,8	16,9	25,0	22,2 (7/8)	30,1	9,6	50
HPC5/16-N01G	5/16	N 1/8	9,1	17,5	21,4	19,0 (3/4)	28,4	5,6	100
HPC5/16-N02G	5/16	N 1/4	13,2	17,5	21,4	19,0 (3/4)	27,9	5,2	50
HPC5/16-N03G	5/16	N 3/8	13,8	17,5	21,4	19,0 (3/4)	26,5	6,0	50
HPC5/16-N04G	5/16	N 1/2	17,8	17,5	25,0	22,2 (7/8)	33,5	11,5	50
HPC3/8-N01G	3/8	N 1/8	9,1	20,2	23,0	20,6 (13/16)	30,4	6,7	50
HPC3/8-N02G	3/8	N 1/4	13,2	20,2	23,0	20,6 (13/16)	34,3	7,9	50
HPC3/8-N03G	3/8	N 3/8	13,8	20,2	23,0	20,6 (13/16)	29,9	7,5	50
HPC3/8-N04G	3/8	N 1/2	17,8	20,2	25,0	22,2 (7/8)	33,9	11,0	50
HPC1/2-N03G	1/2	N 3/8	13,8	25,1	27,4	24,5 (31/32)	38,4	11,7	50
HPC1/2-N04G	1/2	N 1/2	17,8	25,1	27,4	24,5 (31/32)	37,9	12,7	50



# Inch Fittings



Male connector MFL - Diritto maschio MFL

## HPC-MFL

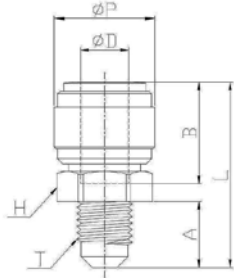

CODE	ØD	T (MFL)	A	B	ØP	H	L	WEIGHT (G)	☐
HPC3/8-MFL02G	3/8	1/4	13,2	20,2	20,0	17	36,9	7,3	50

Female adapter BSPP with internal flat gasket - Diritto femmina BSPP con guarnizione piana interna

## HCF-G

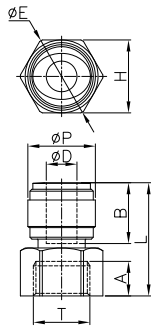

\*

\*

CODE	ØD	T (BSPP)	ØP	L	A	B	H	ØE	WEIGHT (G)	☐
HCF1/4-G03G	1/4	G 3/8	15,0	29,6	9,0	16,9	24	27,3	8,6	50
HCF1/4-G04G	1/4	G 1/2	20,0	37,6	12,5	16,9	27	30,0	13,9	25
HCF1/4-G06G	1/4	G 3/4	15,5	34,2	7,0	16,9	36,7	41,6	36,3	20
HCF3/8-G03G	3/8	G 3/8	20,0	37,1	9,0	20,2	24	27,3	13,9	25
HCF3/8-G04G	3/8	G 1/2	20,0	38,4	12,5	20,2	27	30,0	13,4	25
HCF3/8-G05G	3/8	G 5/8	20,0	38,2	13,5	20,2	29	32,0	14,8	25
HCF3/8-G06G	3/8	G 3/4	20,0	37,0	7,0	20,2	36,7	41,6	39,3	20
HCF1/2-G04G	1/2	G 1/2	23,0	41,9	12,5	25,1	27	30,0	15,5	25



\* brass thread filetto in ottone

for dispensing equipments, we highly recommend the following: - per impianti di spillatura, suggeriamo i seguenti:

CODE	ØD	T (BSPP)	ØP	L	A	B	H	ØE	WEIGHT (G)	☐
HCF5/16-G05G-H	5/16	G 5/8	20,0	34,8	9,5	17,5	28	30,4	13	25
HCF3/8-G04G-H	3/8	G 1/2	20,0	34,2	9,0	20,2	25	27,5	10,7	25
HCF3/8-G05G-H	3/8	G 5/8	20,0	35,2	9,5	20,2	28	30,4	13,2	25

Female adapter NPTF - Diritto femmina NPTF

## HCF-N

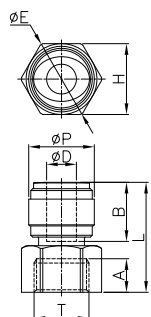

NEW

CODE	ØD	T (NPTF)	ØP	L	A	B	H	ØE	WEIGHT (G)	☐
HCF1/4-N01G	1/4	N 1/8	15,5	30,9	11,5	16,9	17	19,0	6,1	50
HCF1/4-N02G	1/4	N 1/4	15,5	30,9	11,5	16,9	19	21,5	6,5	50
HCF5/16-N02G	5/16	N 1/4	20,0	33,8	11,5	17,5	19	21,5	8,8	50
HCF3/8-N02G	3/8	N 1/4	20,0	34,2	11,5	20,2	19	21,5	8,5	50

# Inch Fittings



Female adapter UN - Diritto femmina UN

## HCF-UN

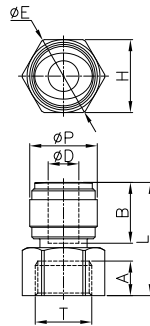

CODE	ØD	T (UN)	ØP	L	A	B	H	ØE	WEIGHT (G)	☐
HCF3/8-UN1/2-16G	3/8	1/2 - 16	20,0	36,7	12,5	20,2	19	21,5	8,9	50
HCF1/2-UN1/2-16G	1/2	1/2 - 16	23,6	40,6	12,5	25,1	19	21,5	11,8	50

Female adapter UNF - Diritto femmina UNF

## HCF-UNF

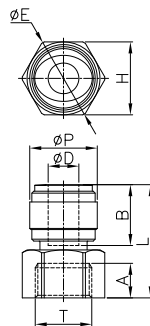

CODE	ØD	T (UNF)	ØP	L	A	B	H	ØE	WEIGHT (G)	☐
HCF1/4-UNF7/16-20G	1/4	7/16-20	17,6	30,1	9,5	16,9	17	19,0	6,6	50
HCF5/16-UNF7/16-20G	5/16	7/16-20	17,6	30,5	9,5	17,5	17	19,0	6,5	50
HCF3/8-UNF7/16-20G	3/8	7/16-20	20,0	33,2	9,5	20,2	17	19,0	7,5	50

Female adapter UNS with internal flat gasket - Diritto femmina UNS con guarnizione piana interna

## HCF-UNS

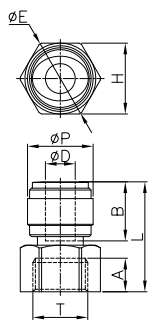

NEW

CODE	ØD	T (UNS)	ØP	L	A	B	H	ØE	WEIGHT (G)	☐
HCF1/4-UNS7/16-24G	1/4	7/16-24	17,6	27,1	6,7	16,9	17	19,0	6,0	50
HCF5/16-UNS7/16-24G	5/16	7/16-24	17,6	27,5	6,7	17,5	17	19,0	6,1	50
HCF3/8-UNS7/16-24G	3/8	7/16-24	20,0	30,2	6,7	20,2	17	19,0	7,4	50

Female adapter NH with internal flat gasket - Diritto femmina NH con guarnizione piana interna

## HCF-NH



brass thread  
filetto in ottone

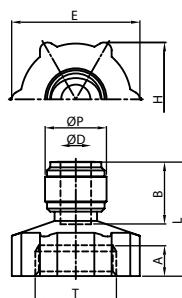

CODE	ØD	T (NH)	ØP	L	A	B	H	ØE	WEIGHT (G)	☐
HCF1/4-NH06G	1/4	3/4	15,5	34,2	7,0	16,9	36,7	41,6	34,6	20
HCF5/16-NH06G	5/16	3/4	20,0	36,6	7,0	17,5	36,7	41,6	36,5	20
HCF3/8-NH06G	3/8	3/4	20,0	37,0	7,0	20,2	36,7	41,6	37,8	20

# Inch Fittings



## Male elbow NPTF - Gomito maschio NPTF

### HPL-N

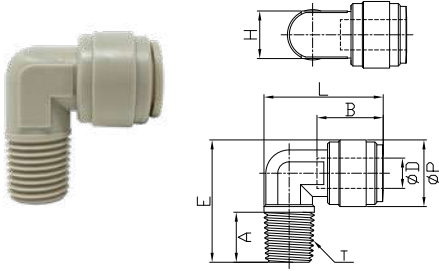

CODE	ØD	T (NPTF)	ØP	A	B	E	H	L	WEIGHT (G)	☐
HPL5/32-N01G	5/32	N 1/8	15,5	9,1	14,7	26,4	11,0 (7/16)	25,4	4,9	100
HPL3/16-N01G	3/16	N 1/8	15,5	9,1	15,0	26,4	11,0 (7/16)	25,6	4,7	100
HPL1/4-N01G	1/4	N 1/8	15,5	9,1	16,9	26,4	11,0 (7/16)	25,6	4,2	100
HPL1/4-N02G	1/4	N 1/4	15,5	13,2	16,9	31,9	11,0 (7/16)	27,0	5,7	50
HPL1/4-N03G	1/4	N 3/8	15,5	13,8	16,9	32,7	11,0 (7/16)	28,9	7,1	50
HPL5/16-N02G	5/16	N 1/4	20,0	13,2	17,5	35,2	14,3 (9/16)	31,4	9,0	50
HPL5/16-N03G	5/16	N 3/8	20,0	13,8	17,5	35,8	14,3 (9/16)	33,5	10,3	50
HPL3/8-N02G	3/8	N 1/4	20,0	13,2	20,2	35,2	14,3 (9/16)	31,8	8,6	50
HPL3/8-N03G	3/8	N 3/8	20,0	13,8	20,2	35,8	14,3 (9/16)	33,9	9,9	50
HPL1/2-N03G	1/2	N 3/8	23,6	13,8	25,1	39,3	17,4 (11/16)	39,7	13,3	25
HPL1/2-N04G	1/2	N 1/2	23,6	17,8	25,1	43,3	17,4 (11/16)	41,5	16,2	25

## Bulkhead connector with gasket - Passaparete con guarnizione

### HMM

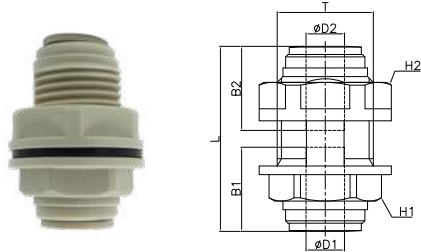

CODE	ØD1	ØD2	T	L	B1	B2	H1 (Fixed)	H2	WEIGHT (G)	☐
HMM5/32-5/32G	5/32	5/32	M15x1,5p	32,4	14,7	14,7	17	18	6,9	50
HMM1/4-1/4G	1/4	1/4	M17x1,5p	35,7	16,9	16,9	19	21	9,4	50
HMM5/16-5/16G	5/16	5/16	M20x1,75p	38,5	17,5	17,5	21	25,5	14,2	25
HMM3/8-3/8G	3/8	3/8	M24x1,75p	42,4	20,2	20,2	24	28,5	20,1	25
HMM1/2-1/2G	1/2	1/2	M27x2,0p	51,8	25,1	25,1	27	31	27,6	20

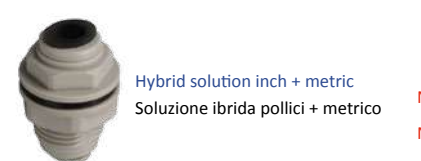

Hybrid solution inch + metric  
Soluzione ibrida pollici + metrico

NEW

NEW

CODE	ØD1	ØD2	T	L	B1	B2	H1 (Fixed)	H2	WEIGHT (G)	☐
HMM1/4-3/8G	1/4	3/8	M24x1,75p	47,9	16,9	20,2	24	28,5	20,9	25

CODE	ØD1	ØD2	T	L	B1	B2	H1 (Fixed)	H2	WEIGHT (G)	☐
HMM06-1/4G	06	1/4	M17x1,5p	35,7	16,1	16,9	19	21	9,8	50
HMM1/4-06G	1/4	06	M17x1,5p	35,7	16,9	16,1	19	21	9,8	50

## Reducer - Riduzione

### HGJ

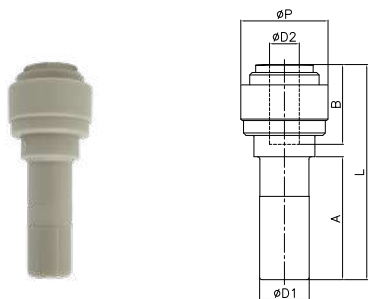

NEW

CODE	ØD1	ØD2	ØP	L	A	B	WEIGHT (G)	☐
HGJ1/4-5/32G	1/4	5/32	13,2	36,7	21,0	14,7	2,4	100
HGJ5/16-1/4G	5/16	1/4	15,5	40,6	22,5	16,9	3,4	100
HGJ3/8-3/16G	3/8	3/16	13,8	41,8	24,8	15,0	3,3	50
HGJ3/8-1/4G	3/8	1/4	17,6	43,9	24,8	16,9	4,7	50
HGJ3/8-5/16G	3/8	5/16	17,6	44,3	24,8	17,5	4,6	50
HGJ1/2-3/8G	1/2	3/8	20,0	51,7	29,5	20,2	7,1	50

CODE	ØD1	ØD2	ØP	L	A	B	WEIGHT (G)	☐
HGJ5/16-3/8G	5/16	3/8	20,0	45,0	22,5	20,2	5,9	50
HGJ3/8-1/2G	3/8	1/2	23,6	52,1	24,8	25,1	9,0	50

## Enlarger - Maggiorazione

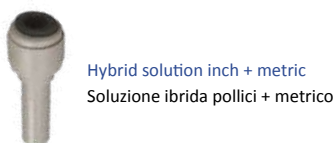

Hybrid solution inch + metric  
Soluzione ibrida pollici + metrico

CODE	ØD1	ØD2	ØP	L	A	B	WEIGHT (G)	☐
HGJ1/2-15G	1/2	15	28,0	61,7	29,5	29,4	15,2	25

# Inch Fittings



## Male stem adapter NPTF - Adattatore a codolo maschio NPTF

### H CJ-N

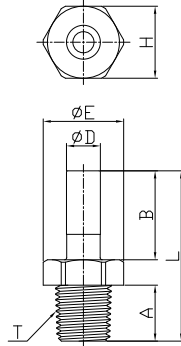

CODE	ØD	T (NPTF)	A	B	ØE	H	L	WEIGHT (G)	☐
H CJ5/32-N01G	5/32	N 1/8	9,1	18,0	14,1	12,7 (1/2)	33,1	1,9	100
H CJ5/32-N02G	5/32	N 1/4	13,2	18,0	17,8	15,8 (5/8)	37,2	3,6	100
H CJ3/16-N01G	3/16	N 1/8	9,1	18,0	14,1	12,7 (1/2)	33,1	2,0	100
H CJ1/4-N01G	1/4	N 1/8	9,1	19,0	14,1	12,7 (1/2)	34,1	2,1	100
H CJ1/4-N02G	1/4	N 1/4	13,2	19,0	17,8	15,8 (5/8)	38,2	3,8	100
H CJ5/16-N01G	5/16	N 1/8	9,1	20,0	14,1	12,7 (1/2)	35,1	2,8	100
H CJ5/16-N02G	5/16	N 1/4	13,2	20,0	17,8	15,8 (5/8)	39,2	3,9	50
H CJ5/16-N03G	5/16	N 3/8	13,8	20,0	21,5	19,0 (3/4)	40,3	5,9	50
H CJ3/8-N02G	3/8	N 1/4	13,2	23,0	17,8	15,8 (5/8)	42,2	4,5	50
H CJ3/8-N03G	3/8	N 3/8	13,8	23,0	21,5	19,0 (3/4)	43,3	6,5	50
H CJ1/2-N03G	1/2	N 3/8	13,8	27,0	21,5	19,0 (3/4)	47,3	6,9	50
H CJ1/2-N04G	1/2	N 1/2	17,8	27,0	26,8	23,8 (15/16)	51,3	11,4	25

## Union elbow tube with stem - Raccordo a gomito con codolo

### H LJ

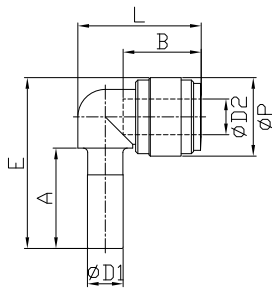

CODE	ØD1	ØD2	ØP	A	B	E	L	WEIGHT (G)	☐
H LJ5/32-5/32G	5/32	5/32	13,2	18,0	14,7	30,1	21,9	2,5	100
H LJ3/16-3/16G	3/16	3/16	13,8	18,5	15,0	31,4	22,5	2,9	100
H LJ1/4-1/4G	1/4	1/4	15,5	21,0	16,9	34,8	25,1	3,7	100
H LJ5/16-5/16G	5/16	5/16	17,6	22,5	17,5	38,3	27,7	5,4	50
H LJ3/8-3/8G	3/8	3/8	20,0	24,8	20,2	43,2	31,4	7,9	50
H LJ1/2-1/2G	1/2	1/2	23,6	29,5	25,1	51,2	39,2	12,7	25

## Reduction - Riduzione

CODE	ØD1	ØD2	ØP	A	B	E	L	WEIGHT (G)	☐
H LJ3/8-1/4G	3/8	1/4	15,5	24,8	16,9	38,6	25,1	4,5	50
H LJ3/8-5/16G	3/8	5/16	20,0	24,8	17,5	43,2	31,0	8,1	50

## Enlarger - Maggiorazione



Hybrid solution inch + metric  
Soluzione ibrida pollici + metrico

CODE	ØD1	ØD2	ØP	A	B	E	L	WEIGHT (G)	☐
<b>NEW</b> H LJ1/4-5/16G	1/4	5/16	17,6	21,0	17,5	36,8	25,7	4,5	50
<b>NEW</b> H LJ1/4-06B	1/4	06	15,5	21,0	16,1	34,8	24,1	3,8	100
<b>NEW</b> H LJ3/8-06B	3/8	06	15,5	24,8	16,1	38,6	25,1	4,5	50

## Branch tee union - Intermedio a T

### H TJ

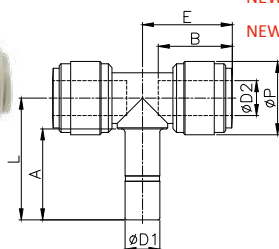

CODE	ØD1	ØD2	ØP	L	E	A	B	WEIGHT (G)	☐
<b>NEW</b> H TJ1/4-1/4G	1/4	1/4	15,5	27,0	20,1	21,0	16,9	6,3	50
<b>NEW</b> H TJ3/8-3/8G	3/8	3/8	20,0	33,2	24,5	24,8	20,2	12,2	25

# Inch Fittings



## Run male tee with stem - T laterale con codolo

### HSJ

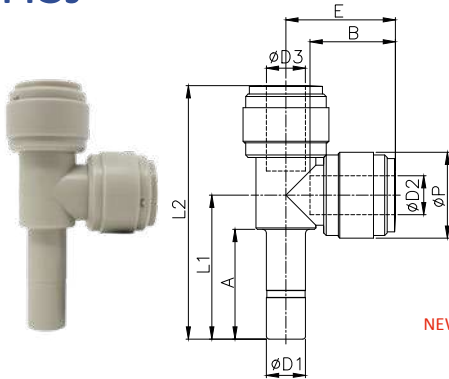

CODE	ØD1	ØD2	ØD3	ØP	A	B1	B2	E	L1	L2	WEIGHT (G)	
HSJ5/32-5/32G	5/32	5/32	5/32	13,2	18,0	14,7	14,7	17,7	23,5	41,2	4,5	100
HSJ1/4-1/4G	1/4	1/4	1/4	15,5	21,0	16,9	16,9	21,0	27,0	48,0	6,4	50
HSJ5/16-5/16G	5/16	5/16	5/16	17,6	22,5	17,5	17,5	22,5	29,5	52,0	9,1	50
HSJ3/8-3/8G	3/8	3/8	3/8	20,0	24,8	20,2	20,2	25,9	33,2	59,1	12,7	25
HSJ1/2-1/2G	1/2	1/2	1/2	23,6	29,5	25,1	25,1	32,5	39,4	71,9	20,7	20

NEW

CODE	ØD1	ØD2	ØD3	ØP	A	B1	B2	E	L1	L2	WEIGHT (G)	
HSJ1/2-3/8-1/2G	1/2	3/8	1/2	23,6	29,5	20,2	25,1	31,7	39,4	71,9	22,2	20

## Pluggable cooling manifold with separate ways - Collettore di raffreddamento innestabile con vie separate

### HBUJ

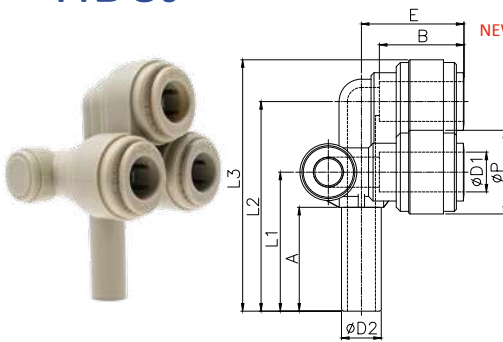

NEW

CODE	ØD1	ØD2	ØP	A	B	E	L1	L2	L3	WEIGHT (G)	
HBUJ3/8-3/8G	G 3/8	G 3/8	20,0	24,8	20,0	24,5	33,2	50,05	60,05	20,2	15

technical datasheet available on request - scheda tecnica disponibile su richiesta

## Union connector - Intermedio dritto

### HUC

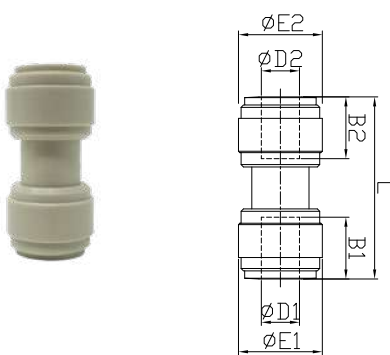

NEW

CODE	ØD1	ØD2	B1	B2	ØE1	ØE2	L	WEIGHT (G)	
HUC5/32-5/32G	5/32	5/32	14,7	14,7	13,2	13,2	31,8	3,8	100
HUC3/16-3/16G	3/16	3/16	15,0	15,0	13,8	13,8	32,5	4,0	100
HUC1/4-1/4G	1/4	1/4	16,9	16,9	15,5	15,5	36,2	5,2	100
HUC5/16-5/16G	5/16	5/16	17,5	17,5	17,6	17,6	38,2	6,9	50
HUC3/8-3/8G	3/8	3/8	20,2	20,2	20,0	20,0	42,9	9,7	50
HUC1/2-1/2G	1/2	1/2	25,1	25,1	23,6	23,6	53,2	14,6	25

NEW

CODE	ØD1	ØD2	B1	B2	ØE1	ØE2	L	WEIGHT (G)	
HUC5/16-5/32G	5/16	5/32	17,5	14,7	17,6	17,6	36,6	6,5	50
HUC5/16-1/4G	5/16	1/4	17,5	16,9	17,6	17,6	36,8	6,0	50
HUC3/8-3/16G	3/8	3/16	20,2	15,0	20,0	13,8	37,2	6,9	50
HUC3/8-1/4G	3/8	1/4	20,2	16,9	20,0	15,5	38,5	7,3	50
HUC3/8-5/16G	3/8	5/16	20,2	17,5	20,0	20,0	42,5	9,9	50
HUC1/2-5/16G	1/2	5/16	25,1	17,5	23,6	17,6	44,6	11,2	25
HUC1/2-3/8G	1/2	3/8	25,1	20,2	23,6	23,6	52,4	16,3	25

NEW

CODE	ØD1	ØD2	B1	B2	ØE1	ØE2	L	WEIGHT (G)	
HUC1/4-06G	1/4	06	16,9	16,1	15,5	15,5	36,2	5,3	100



# Inch Fittings



Union elbow - Intermedio a gomito

## HUL



CODE	ØD1	ØD2	B1	B2	ØE1	ØE2	L	H	WEIGHT (G)	☐
HUL5/32-5/32G	5/32	5/32	14,7	14,7	13,2	13,2	24,5	24,5	4,0	100
HUL3/16-3/16G	3/16	3/16	15,0	15,0	13,8	13,8	25,5	25,5	4,3	100
HUL1/4-1/4G	1/4	1/4	16,9	16,9	15,5	15,5	28,8	28,8	5,5	100
HUL5/16-5/16G	5/16	5/16	17,5	17,5	17,6	17,6	30,7	30,7	7,5	50
HUL3/8-3/8G	3/8	3/8	20,2	20,2	20,0	20,0	35,9	35,9	10,6	50
HUL1/2-1/2G	1/2	1/2	25,1	25,1	23,0	23,0	43,4	43,4	16,7	25

CODE	ØD1	ØD2	B1	B2	ØE1	ØE2	L	H	WEIGHT (G)	☐
HUL5/16-5/32G	5/16	5/32	17,5	14,7	17,6	13,2	28,3	29,7	5,9	50
HUL5/16-1/4G	5/16	1/4	17,5	16,9	17,6	17,6	30,7	30,3	7,6	50
HUL3/8-1/4G	3/8	1/4	20,2	16,9	23,0	17,6	37,9	36,1	12,9	50
HUL3/8-5/16G	3/8	5/16	20,2	17,5	20,0	20,0	35,9	35,5	11,1	50
HUL1/2-5/16G	1/2	5/16	25,1	17,5	23,0	17,6	38,7	36,5	11,5	50
HUL1/2-3/8G	1/2	3/8	25,1	20,2	23,0	23,0	43,4	42,6	17,5	25

Union tee - Intermedio a T

## HUT

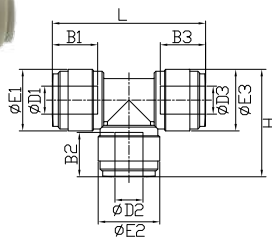

CODE	ØD1	ØD2	ØD3	B1	B2	ØE1	ØE2	H	L	WEIGHT (G)	☐
HUT5/32-5/32G	5/32	5/32	5/32	14,7	14,7	13,2	13,2	24,5	35,8	5,7	100
HUT3/16-3/16G	3/16	3/16	3/16	15,0	15,0	13,8	13,8	25,5	37,2	6,2	100
HUT1/4-1/4G	1/4	1/4	1/4	16,9	16,9	15,5	15,5	28,8	42,0	8,1	50
HUT5/16-5/16G	5/16	5/16	5/16	17,5	17,5	17,6	17,6	30,7	43,8	10,6	50
HUT3/8-3/8G	3/8	3/8	3/8	20,2	20,2	20,0	20,0	35,9	51,8	15,4	25
HUT1/2-1/2G	1/2	1/2	1/2	25,1	25,1	23,0	23,0	43,4	63,8	23,2	20

NEW

CODE	ØD1	ØD2	ØD3	B1	B2	ØE1	ØE2	H	L	WEIGHT (G)	☐
HUT3/8-1/4-3/8G	3/8	1/4	3/8	20,2	16,9	20,0	15,0	32,1	48,8	12,2	25
HUT1/2-3/8-1/2G	1/2	3/8	1/2	24,6	20,2	23,0	23,0	42,6	63,8	25,3	20

# Inch Fittings



Union Y - Intermedio a Y

## HUY

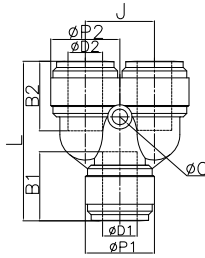

CODE	ØD1	ØD2	B1	B2	ØP1	ØP2	L	J	C	WEIGHT (G)	
HUY5/32-5/32G	5/32	5/32	14,7	14,7	13,8	13,8	33,7	13,5	3,3	6,7	100
HUY3/16-3/16G	3/16	3/16	15,0	15,0	13,8	13,8	34,1	13,5	3,3	6,8	50
HUY1/4-1/4G	1/4	1/4	16,9	16,9	15,5	15,5	38,8	15,5	3,3	8,8	50
HUY5/16-5/16G	5/16	5/16	17,5	17,5	17,6	17,6	41,0	17,6	4,5	11,8	50
HUY3/8-3/8G	3/8	3/8	20,2	20,2	20,0	20,0	46,4	20,0	4,5	16,7	25
HUY1/2-1/2G	1/2	1/2	25,1	25,1	23,0	23,0	56,8	23,0	4,5	25,1	20

3 ways divider - Intermedio a 3 vie diritto

## HTWD

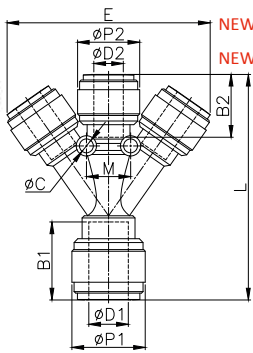

CODE	ØD1	ØD2	ØP1	ØP2	B1	B2	L	E	M	ØC	WEIGHT (G)	
HTWD3/8-1/2G	1/2	3/8	23,6	20,0	25,1	20,2	72,6	65,4	14,2	4,5	27,3	20
HTWD1/2-1/2G	1/2	1/2	23,6	23,6	25,1	25,1	82,9	80,3	16,6	4,5	37,4	20

HTWD3/8-1/2G: single plastic bag

Cooling manifold - Collettore di raffreddamento

## HUTT

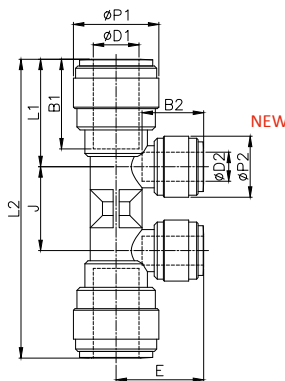

CODE	ØD1	ØD2	ØP1	ØP2	B1	B2	L1	L2	E	J	WEIGHT (G)	
NEW HUTT1/2-3/8-1/2G	1/2	3/8	23,6	23,6	25,1	20,2	32,5	111,1	31,7	46,7	47,5	20
CODE	ØD1	ØD2	ØP1	ØP2	B1	B2	L1	L2	E	J	WEIGHT (G)	
NEW HUTT15-3/8-15G	15	3/8	28,0	20,0	29,4	20,2	35,3	98,0	28,7	27,5	38,6	20

# Inch Fittings



U-Bend - Doppia giunzione a U

## HBU

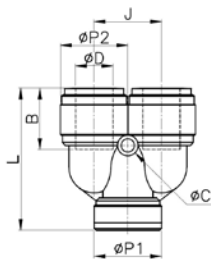

CODE	ØD	B	ØP1	ØP2	L	J	ØC	WEIGHT (G)	
HBU3/8-3/8G	3/8	20,2	20,0	20,0	41,9	20,0	4,5	16,7	25
HBU1/2-1/2G	1/2	25,1	23,0	23,0	48,3	23,0	4,5	23,9	20

Tube barb connector - Codolo portagomma diritto

## HCJB

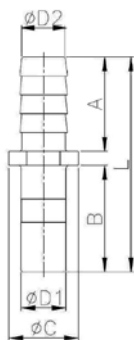

CODE	ØD1	ØD2	BARB	ØC	L	A	B	WEIGHT (G)	
HCJB1/4-1/4G	1/4	1/4	6,85	11,8	39,0	18,0	18,0	1,2	100
HCJB5/16-5/16G	5/16	5/16	8,60	12,2	40,0	18,0	19,0	2,1	100
HCJB3/8-3/8G	3/8	3/8	10,0	14,7	45,5	20,0	22,5	2,5	100
<b>NEW</b> HCJB1/2-1/2G	1/2	1/2	13,2	20,5	50,5	20,0	27,5	5,1	50

CODE	ØD1	ØD2	BARB	ØC	L	A	B	WEIGHT (G)	
<b>NEW</b> HCJB1/4-3/16G	1/4	3/16	5,3	11,8	38,9	17,9	18,0	1,1	100
<b>NEW</b> HCJB5/16-3/8G	5/16	3/8	10,0	12,2	42,0	20,0	22,0	2,3	100
HCJB3/8-1/4G	3/8	1/4	6,85	14,7	43,5	18,0	22,5	2,2	100
HCJB3/8-5/16G	3/8	5/16	8,60	14,7	43,5	18,0	22,5	2,6	100
HCJB1/2-3/8G	1/2	3/8	10,0	18,5	50,5	20,0	27,5	4,1	50

Elbow tube barb connector - Codolo portagomma a gomito

## HLJB

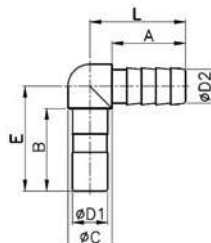

CODE	ØD1	ØD2	BARB	ØC	L	E	A	B	WEIGHT (G)	
<b>NEW</b> HLJB3/8-1/4G	3/8	1/4	6,85	-	-	-	-	-	-	-
HLJB3/8-5/16G	3/8	5/16	8,6	12,0	24,0	28,5	18,0	22,5	3,1	100
HLJB3/8-3/8G	3/8	3/8	10,0	12,0	26,0	28,5	20,0	22,5	3,3	100



# Inch Fittings



Male plug - Tappo maschio

## HPP

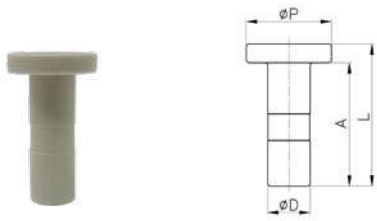

CODE	ØD	ØP	L	A	WEIGHT (G)	
HPP5/32G	5/32	13,0	22,5	19,0	0,8	200
HPP3/16G	3/16	13,0	22,5	19,0	0,9	200
HPP1/4G	1/4	13,0	24,5	21,0	1,2	200
HPP5/16G	5/16	16,0	26,5	23,0	1,8	100
HPP3/8G	3/8	18,0	30,0	26,0	2,7	100
HPP1/2G	1/2	21,5	34,0	30,0	4,4	100

Female plug - Tappo femmina

## HPF

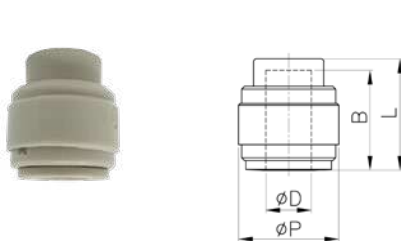

NEW

CODE	ØD	ØP	L	B	WEIGHT (G)	
HPF5/32G	5/32	13,2	16,9	14,7	2,0	100
HPF1/4G	1/4	15,5	18,9	16,9	2,7	100
HPF5/16G	5/16	17,6	19,5	17,5	3,6	100
HPF3/8G	3/8	20,0	22,2	20,2	5,0	100
HPF1/2G	1/2	23,0	26,9	24,9	7,0	50

Male swivel elbow NPTF - Gomito girevole maschio NPTF

## HRPL-N

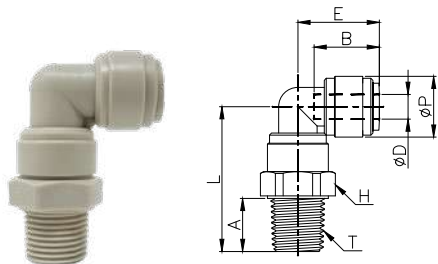

CODE	ØD	T (NPTF)	ØP	A	B	E	H	L	WEIGHT (G)	
HRPL5/32-N01G	5/32	N 1/8	13,2	9,1	14,7	17,9	15,8 (5/8)	29,7	6,4	50
HRPL5/32-N02G	5/32	N 1/4	13,2	13,2	14,7	17,9	15,8 (5/8)	33,8	7,2	50
HRPL1/4-N01G	1/4	N 1/8	15,5	9,1	16,9	21,0	17,46 (11/16)	32,8	8,2	50
HRPL1/4-N02G	1/4	N 1/4	15,5	13,2	16,9	21,0	17,46 (11/16)	36,9	8,9	50
HRPL5/16-N01G	5/16	N 1/8	17,6	9,1	17,5	21,9	19,0 (3/4)	33,8	10,5	25
HRPL5/16-N02G	5/16	N 1/4	17,6	13,2	17,5	21,9	19,0 (3/4)	37,9	11,3	25
HRPL5/16-N03G	5/16	N 3/8	17,6	13,8	17,5	21,9	19,0 (3/4)	38,5	12,3	25
HRPL3/8-N02G	3/8	N 1/4	20,0	13,2	20,2	25,9	21,4 (27/32)	41,9	15,5	25
HRPL3/8-N03G	3/8	N 3/8	20,0	13,0	20,2	25,9	21,4 (27/32)	41,8	16,4	25
HRPL1/2-N03G	1/2	N 3/8	23,0	13,8	25,1	31,9	23,8 (15/16)	48,5	23,3	20
HRPL1/2-N04G	1/2	N 1/2	23,0	17,8	25,1	31,9	23,8 (15/16)	51,5	25,9	20

Male swivel tee NPTF - T girevole maschio NPTF

## HRPT-N

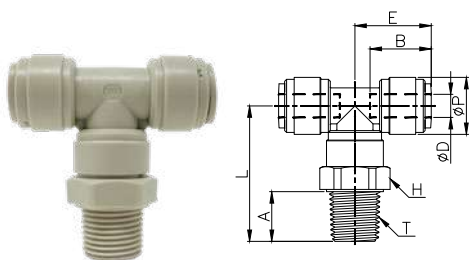

CODE	ØD	T (NPTF)	ØP	A	B	E	H	L	WEIGHT (G)	
HRPT5/32-N01G	5/32	N 1/8	13,2	9,1	14,7	17,8	15,8 (5/8)	29,7	8,1	50
HRPT5/32-N02G	5/32	N 1/4	13,2	13,2	14,7	17,9	15,8 (5/8)	33,8	8,9	50
HRPT1/4-N01G	1/4	N 1/8	15,5	9,1	16,9	21,0	17,46 (11/16)	32,8	10,2	50
HRPT1/4-N02G	1/4	N 1/4	15,5	13,2	16,9	21,0	17,46 (11/16)	36,9	11,3	25
HRPT5/16-N01G	5/16	N 1/8	17,6	9,1	17,5	21,9	19,0 (3/4)	33,8	13,6	25
HRPT5/16-N02G	5/16	N 1/4	17,6	13,2	17,5	21,9	19,0 (3/4)	37,9	14,4	25
HRPT5/16-N03G	5/16	N 3/8	17,6	13,8	17,5	21,9	19,0 (3/4)	38,5	15,4	25
HRPT3/8-N02G	3/8	N 1/4	20,0	13,2	20,2	25,9	21,4 (27/32)	41,9	20,2	25
HRPT3/8-N03G	3/8	N 3/8	20,0	13,0	20,2	25,9	21,4 (27/32)	41,8	20,4	20
HRPT1/2-N03G	1/2	N 3/8	23,0	13,8	25,1	31,9	23,8 (15/16)	48,5	29,8	15
HRPT1/2-N04G	1/2	N 1/2	23,0	17,8	25,1	31,9	23,8 (15/16)	51,5	32,4	12

# Inch Fittings



Male swivel run tee NPTF - T laterale girevole maschio NPTF

## HRST-N

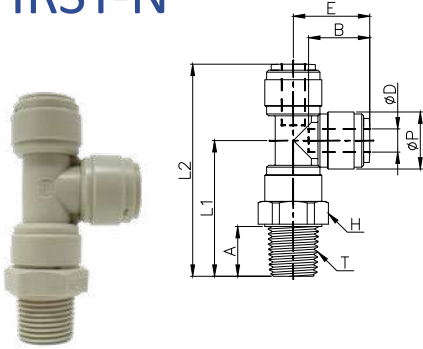

CODE	ØD	T (NPTF)	ØP	A	B	E	H	L1	L2	WEIGHT (G)	
HRST5/32-N01G	5/32	N 1/8	13,2	9,1	14,7	17,9	15,8(5/8)	29,7	47,6	8,1	50
HRST5/32-N02G	5/32	N 1/4	13,2	13,2	14,7	17,9	15,8(5/8)	33,8	51,7	8,9	50
HRST1/4-N01G	1/4	N 1/8	15,5	9,1	16,9	21,0	17,46 (11/16)	32,8	53,8	10,2	50
HRST1/4-N02G	1/4	N 1/4	15,5	13,2	16,9	21,0	17,46 (11/16)	36,9	57,9	11,3	25
HRST5/16-N01G	5/16	N 1/8	17,6	9,1	17,5	21,9	19,0(3/4)	33,8	55,8	13,6	25
HRST5/16-N02G	5/16	N 1/4	17,6	13,2	17,5	21,9	19,0(3/4)	37,9	59,9	14,4	25
HRST5/16-N03G	5/16	N 3/8	17,6	13,8	17,5	21,9	19,0(3/4)	38,5	60,5	15,4	25
HRST3/8-N02G	3/8	N 1/4	20,0	13,2	20,2	25,9	21,4 (27/32)	41,9	57,8	20,2	25
HRST3/8-N03G	3/8	N 3/8	20,0	13,0	20,2	25,9	21,4 (27/32)	41,8	67,7	20,4	20
HRST1/2-N03G	1/2	N 3/8	23,0	13,8	25,1	31,9	23,8(15/16)	48,5	80,4	29,8	15
HRST1/2-N04G	1/2	N 1/2	23,0	17,8	25,1	31,9	23,8(15/16)	51,5	83,4	32,4	12

Male swivel Y NPTF - Y girevole maschio NPTF

## HRWT-N

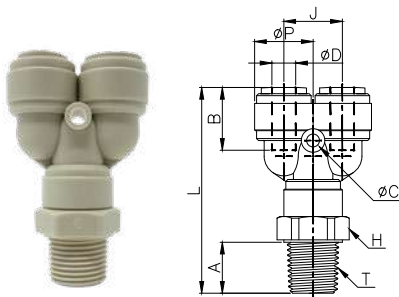

CODE	ØD	T (NPTF)	ØP	A	B	J	H	L	ØC	WEIGHT (G)	
HRWT5/32-N01G	5/32	N 1/8	13,8	9,1	14,7	13,5	15,8(5/8)	36,8	3,3	9,1	50
HRWT5/32-N02G	5/32	N 1/4	13,8	13,2	14,7	13,5	15,8(5/8)	49,6	3,3	9,9	50
HRWT1/4-N01G	1/4	N 1/8	15,5	9,1	16,9	15,5	17,46 (11/16)	50,6	3,3	11,0	50
HRWT1/4-N02G	1/4	N 1/4	15,5	13,2	16,9	15,5	17,46 (11/16)	54,7	3,3	12,2	25
HRWT5/16-N01G	5/16	N 1/8	17,6	9,1	17,5	17,6	19,0(3/4)	52,9	4,5	14,8	25
HRWT5/16-N02G	5/16	N 1/4	17,6	13,2	17,5	17,6	19,0(3/4)	57,0	4,5	15,6	25
HRWT5/16-N03G	5/16	N 3/8	17,6	13,8	17,5	17,6	19,0(3/4)	57,6	4,5	16,6	25
HRWT3/8-N02G	3/8	N 1/4	20,0	13,2	20,2	20,0	21,4 (27/32)	62,4	4,5	21,2	25
HRWT3/8-N03G	3/8	N 3/8	20,0	13,0	20,2	20,0	21,4 (27/32)	62,3	4,5	21,7	25
HRWT1/2-N03G	1/2	N 3/8	23,0	13,8	25,1	23,0	23,8(15/16)	73,4	4,5	31,7	15
HRWT1/2-N04G	1/2	N 1/2	23,0	17,8	25,1	23,0	23,8(15/16)	76,4	4,5	34,3	12

Threaded reducer BSPP with internal flat gasket - Riduzione filettata BSPP con guarnizione piana interna

## HUFF

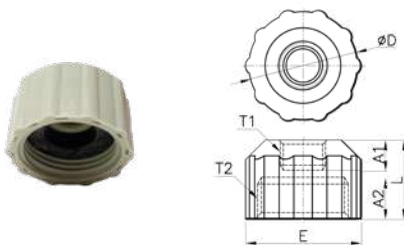

CODE	T1 (BSPP)	T2 (BSPP)	ØD	A1	A2	L	E	WEIGHT (G)	
HUFFG02-G06G	1/4	3/4	31,5	9,5	12,0	23,0	33,5	15,6	100
HUFFG03-G06G	3/8	3/4	31,5	9,5	12,0	23,0	33,5	14,5	100

# Check Valves



## Technical Information

### MATERIALS

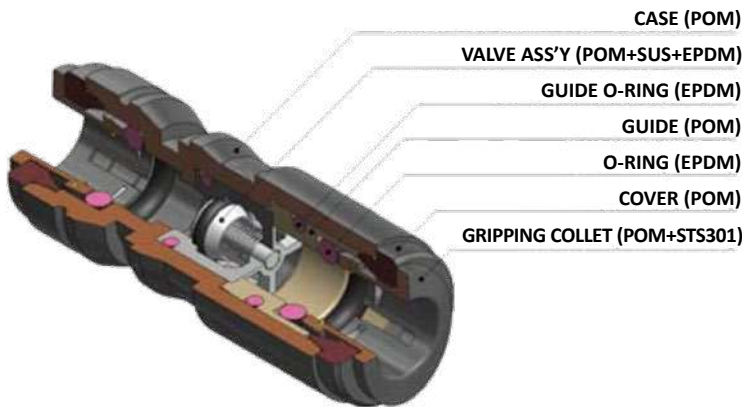

This valve allows one way fluid flow and blocks the reverse flow.

Opening pressure 0,02 Bar.

Compact size and convenient to be used in a narrow space.

Fast installation and easy maintenance.

Questa valvola permette il passaggio del fluido in una direzione e blocca il flusso nel senso opposto.

Pressione di apertura 0,02 Bar.

Dimensione compatta e comoda per essere impiegata in uno spazio ridotto.

Installazione rapida e manutenzione semplice.

The maximum working temperature is 65 °C for continuous use and 90°C for short-term (5 minutes max) use.

La massima temperatura di utilizzo è di 65°C per un uso continuo e di 90°C per un uso massimo di 5 minuti.

The maximum working pressure is 10 bar at 65 °C for continuous use (10 bar at 90°C for short-term 5 minutes max use).

La massima pressione d'esercizio è di 10 bar a 65°C per un uso continuo (10 bar a 90°C per un uso massimo di 5 minuti).

### FLOW CHART

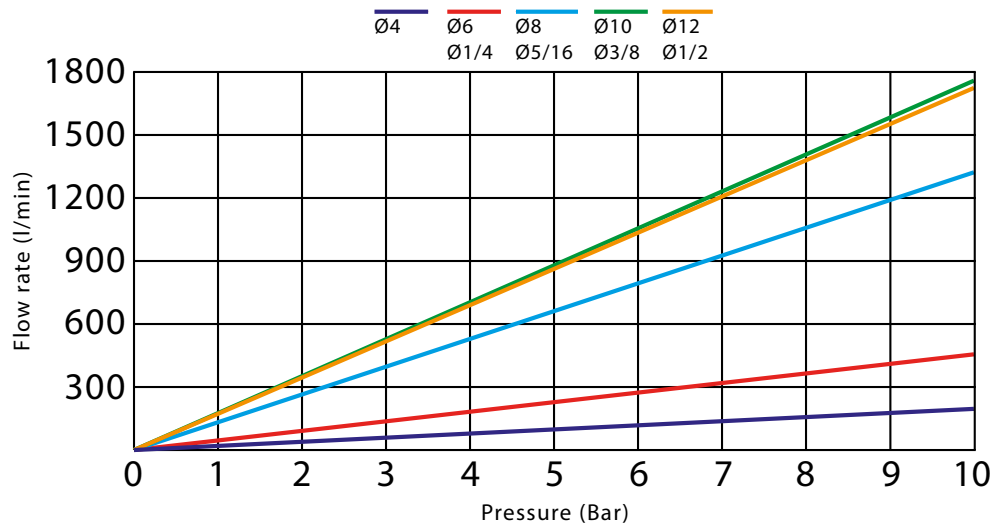

# Check Valves



Metric check valve - Valvola unidirezionale metrica

## HCVU

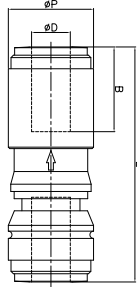

CODE	ØD	ØP	L	B	WEIGHT (G)	☐
HCVU0404B	4	13,2	44,4	14,7	6,1	50
HCVU0606B	6	15,5	45,5	16,1	7,4	50
HCVU0808B	8	17,6	48,6	17,5	10,0	50
HCVU1010B	10	20,0	57,6	19,4	14,5	25
HCVU1212B	12	23,6	67,5	23,9	22,1	25

Inch check valve - Valvola unidirezionale in pollici

## HCVU

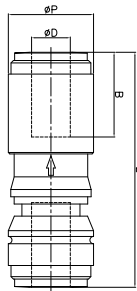

CODE	ØD	ØP	L	B	WEIGHT (G)	☐
HCVU5/32-5/32G	5/32	13,2	44,4	14,7	5,5	50
HCVU1/4-1/4G	1/4	15,5	45,5	16,1	7,4	50
HCVU5/16-5/16G	5/16	17,6	48,6	17,5	10,0	50
HCVU3/8-3/8G	3/8	20,0	57,8	19,5	15,0	25
HCVU1/2-1/2G	1/2	23,6	67,9	24,1	21,5	25

## Technical Information

### MATERIALS

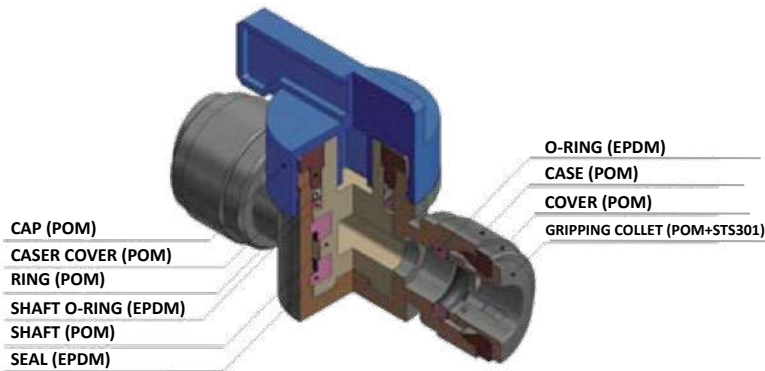

Suitable for air and fluids.

Compact size and convenient to be used in a narrow space.

Maximum flow rate.

The hand valves must only be used in fully open or fully closed position.

Idoneo per aria e fluidi.

Dimensione compatta e comoda per essere impiegata in uno spazio ridotto.

Massima portata.

Le valvole manuali devono essere utilizzate solo in posizione totalmente aperta o totalmente chiusa.

Please check page 4 of the present catalogue for technical data. Page 5 for working pressure and temperatures. Page 5 for instruction and page 8 for warnings and precautions.

Si rimanda a pag. 4 del presente catalogo per i dati tecnici. A pag. 5 per pressioni e temperature d'esercizio. Pag. 6 per istruzioni e pag. 8 per avvertenze e precauzioni.

### 2 ways metric hand valves - Valvola manuale 2 vie metrica

## HBVU

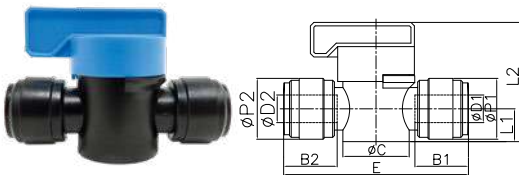

CODE	ØD1	ØD2	B1	B2	ØP1	ØP2	L1	L2	E	ØC	WEIGHT (G)	☐
HBVU0606B	6	6	16,1	16,1	15,5	15,5	9,5	34,5	51,7	19,2	16,0	25
HBVU0808B	8	8	17,5	17,5	17,6	17,6	9,5	34,5	53,5	19,2	17,4	25
HBVU1010B	10	10	20,1	20,1	20,0	20,0	12,5	42,3	63,0	24,2	29,0	15
HBVU1212B	12	12	23,7	23,7	23,0	23,0	12,5	42,3	70,4	24,2	35,4	15

### 2 ways inch hand valves - Valvola manuale 2 vie in pollici

## HBVU

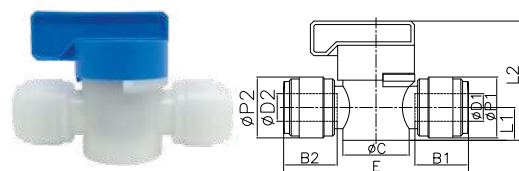

CODE	ØD1	ØD2	B1	B2	ØP1	ØP2	L1	L2	E	ØC	WEIGHT (G)	☐
HBVU 1/4-1/4W	1/4	1/4	16,1	16,1	15,5	15,5	9,5	34,5	51,7	19,2	16,0	25
HBVU 5/16-5/16W	5/16	5/16	17,5	17,5	17,6	17,6	9,5	34,5	53,5	19,2	17,4	25
HBVU 3/8-3/8W	3/8	3/8	20,2	20,2	20,0	20,0	12,5	42,3	63,2	24,2	29,0	15
HBVU 1/2-1/2W	1/2	1/2	23,9	23,9	23,0	23,0	12,5	42,3	70,8	24,2	35,4	15

# Hand Valves



2 ways metric hand valves male thread BSPT - Valvola manuale 2 vie metrica BSPT

## HBVL-R

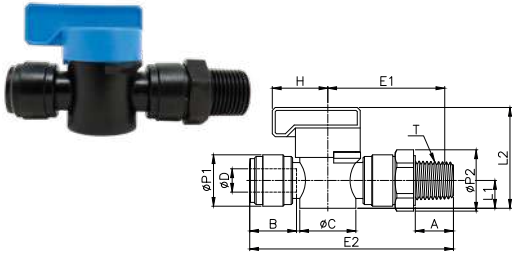

CODE	ØD	T (BSPT)	B	A	ØP1	ØP2	L1	L2	E1	E2	H	ØC	WEIGHT (G)	☐
HBVL10R03B	10	R 3/8	20,1	13,5	20	23,0	12,5	42,3	48,3	79,8	26,3	24,2	34,3	15

Elbow inch hand valve female thread BSPP - Valvola manuale 2 vie a gomito femmina BSPP in pollici

## HESV

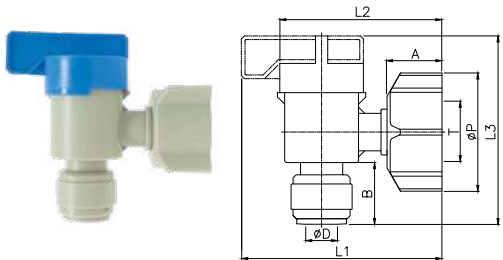

NEW

CODE	ØD	T (BSPP)	ØP	A	B	L1	L2	L3	WEIGHT (G)	☐
HESV3/8-G04G	3/8	G 1/2	38,7	18,0	20,2	65,75	53,15	61,7	35,3	20

technical datasheet available on request - scheda tecnica disponibile su richiesta

3 ways inch hand valve with tee direction - Valvola manuale 3 vie con direzione a T in pollici

## HASV

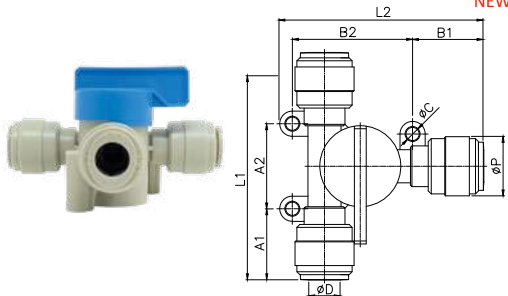

NEW

CODE	ØD	ØP	A1	A2	B1	B2	L1	L2	WEIGHT (G)	☐
HASV3/8-3/8G	3/8	20,0	24,1	28,8	24,1	40,7	77,0	69,05	44,8	20

technical datasheet available on request - scheda tecnica disponibile su richiesta

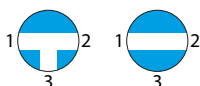

# Valved Barb Connector



## Technical Information

### MATERIALS

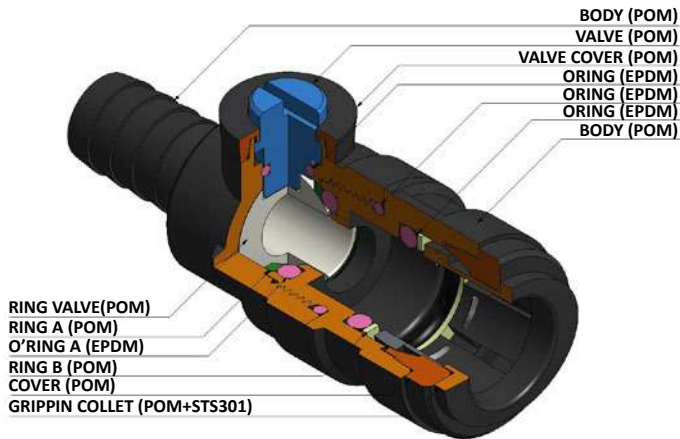

These valves are specially designed for mounting with flexible tubes and allow to stop the flow in case of need.

Queste valvole sono appositamente studiate per il montaggio con tubi flessibili e consentono di arrestare il flusso in caso di necessità.

Please check page 4 of the present catalogue for technical data. Page 5 for working pressure and temperatures. Page 5 for instruction and page 8 for warnings and precautions.

Si rimanda a pag. 4 del presente catalogo per i dati tecnici. A pag. 5 per pressioni e temperature d'esercizio. Pag. 6 per istruzioni e pag. 8 per avvertenze e precauzioni.

Valved barb connector - Portagomma valvolato

## HCVB

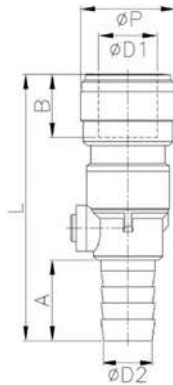

CODE	ØD1	ØD2	BARB	ØP	L	A	B	WEIGHT (G)	
HCVB15-1/2B	15	1/2	13,3	28,5	74,2	22,3	29,4	29,3	20
HCVB22-1/2B	22	1/2	13,3	35,7	87,3	22,3	33,8	38,9	20
HCVB22-3/4B	22	3/4	20,25	35,7	99,0	30,0	33,8	47,7	20





## Technical Information

### FLOW REGULATORS BULKHEAD - MATERIALS

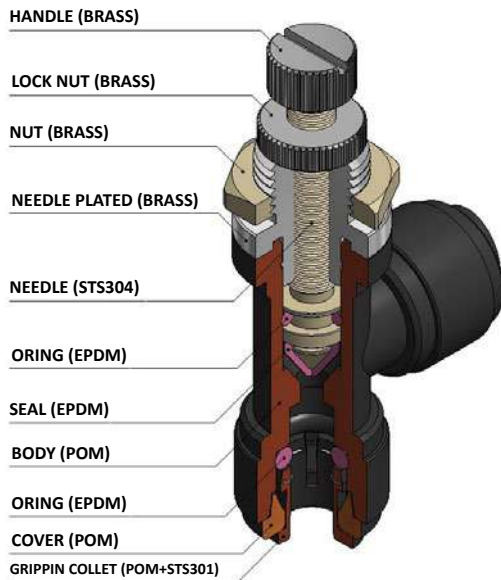

Thanks to the bulkhead system, the regulators of the Fluidfit range allow a precise regulation of the flow acting outside the devices even if they are placed inside.

I regolatori della gamma Fluidfit, grazie al sistema passa parete, consentono un'accurata regolazione del flusso agendo dall'esterno degli apparecchi pur essendo posizionati al loro interno.

Please check page 4 of the present catalogue for technical data. Page 5 for working pressure and temperatures. Page 5 for instruction and page 8 for warnings and precautions.

Si rimanda a pag. 4 del presente catalogo per i dati tecnici. A pag. 5 per pressioni e temperature d'esercizio. Pag. 6 per istruzioni e pag. 8 per avvertenze e precauzioni.

### FLOW REGULATORS - MATERIALS

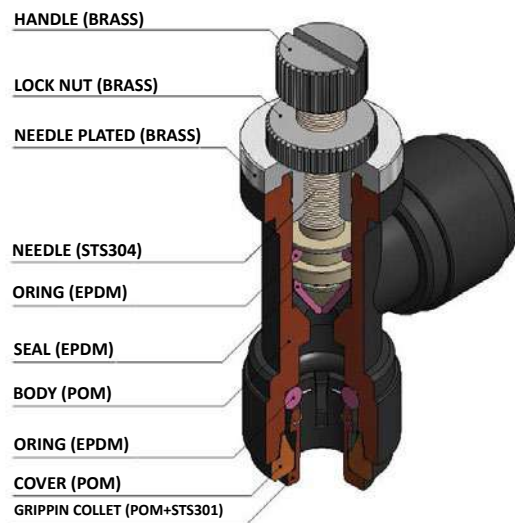

The regulators of the Fluidfit range allow a precise regulation of the flow.

I regolatori della gamma Fluidfit consentono un'accurata regolazione del flusso.

Please check page 4 of the present catalogue for technical data. Page 5 for working pressure and temperatures. Page 5 for instruction and page 8 for warnings and precautions.

Si rimanda a pag. 4 del presente catalogo per i dati tecnici. A pag. 5 per pressioni e temperature d'esercizio. Pag. 6 per istruzioni e pag. 8 per avvertenze e precauzioni.

# Flow Regulators



## FLOW CHART

### HSLB0606B, HSLB1/4-1/4G, HSLU0606B, HSLU1/4-1/4G

1. Flowrate

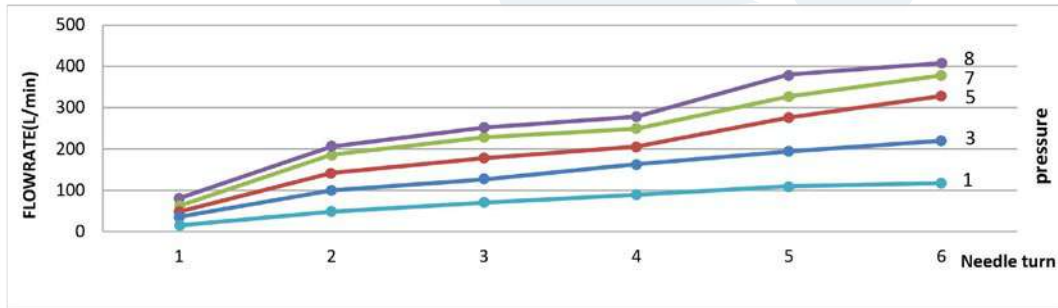

### HSTU0606B, HSTU1/4-1/4G, HSTB0606B, HSTB1/4-1/4G

1. Flowrate

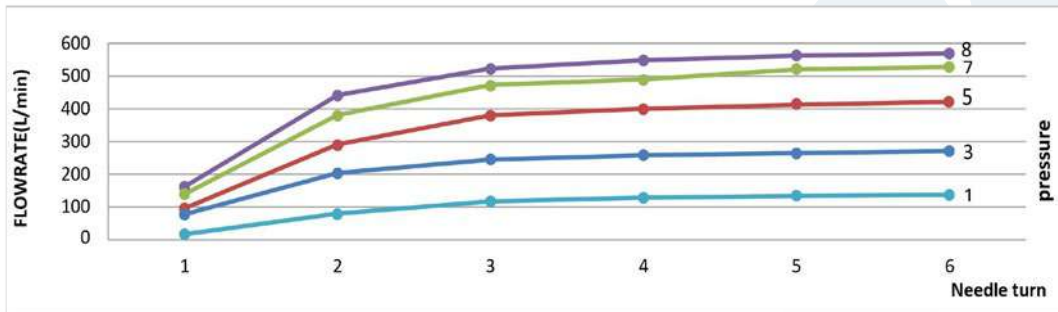

### HSTU3/8-3/8G, HSTU1010B, HSTB1010B, HSTB3/8-3/8G

1. Flowrate

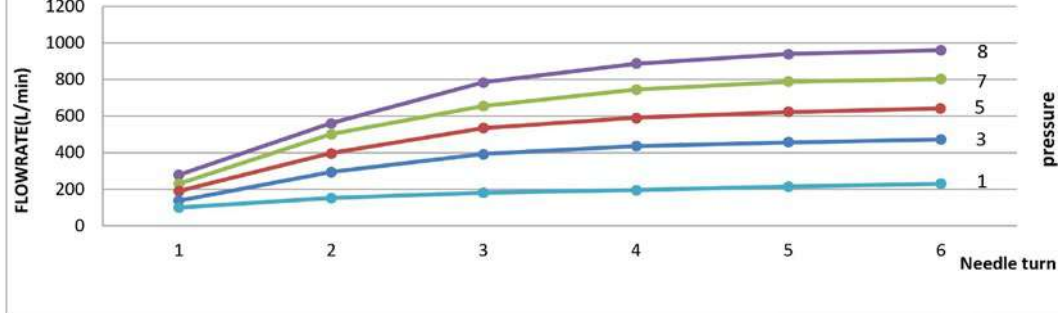

### HSLU3/8-3/8G, HSLU1010B, HSLB3/8-3/8G, HSLB1010B

1. Flowrate

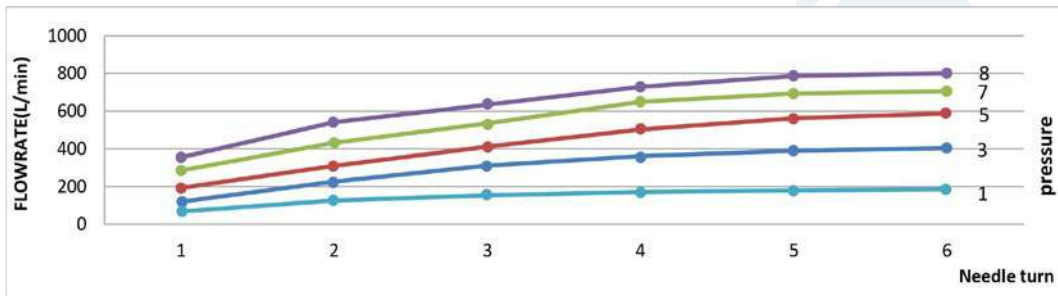

# Flow Regulators Bulkhead



Elbow bulkhead metric flow regulator - Regolatore di flusso passaparete a gomito metrico

## HSLB

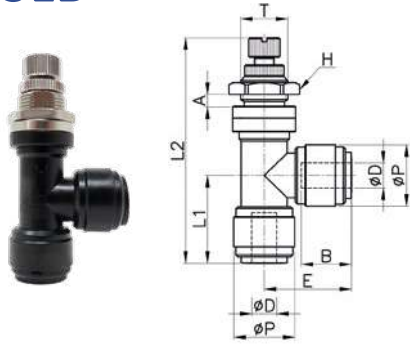

CODE	ØD	ØP	T	L1	L2 MIN	L2 MAX	E	A	B	H	WEIGHT (G)	
HSLB0606B	6	15,5	M12x1,0	22,2	57,1	61,3	22,2	5,0	16,1	16	28,7	50
HSLB1010B	10	20,0	M15x1,0	25,0	67,7	73,4	26,0	6,0	19,7	19	54,0	25

Elbow bulkhead inch flow regulator - Regolatore di flusso passaparete a gomito in pollici

## HSLB

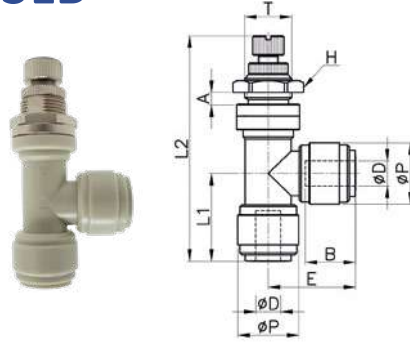

CODE	ØD	ØP	T	L1	L2 MIN	L2 MAX	E	A	B	H	WEIGHT (G)	
HSLB1/4-1/4G	1/4	15,5	M12x1,0	22,2	57,1	61,3	22,2	5,0	16,9	16	28,7	50
HSLB3/8-3/8G	3/8	20,0	M15x1,0	25,0	67,8	73,5	26,0	6,0	19,8	19	54,0	25

Bulkhead metric flow regulator - Regolatore di flusso passaparete in linea metrico

## HSTB



CODE	ØD	ØP	T	E1	E2	L min	L max	A	B	H	WEIGHT (G)	
HSTB0606B	6	15,5	M12xP1	22,2	44,4	45,5	50,4	5,0	16,1	16	28,9	50
HSTB1010B	10	20,0	M15xP1	26,1	52,1	52,7	58,4	6,0	19,7	19	54,0	25

Bulkhead inch flow regulator - Regolatore di flusso passaparete in linea in pollici

## HSTB

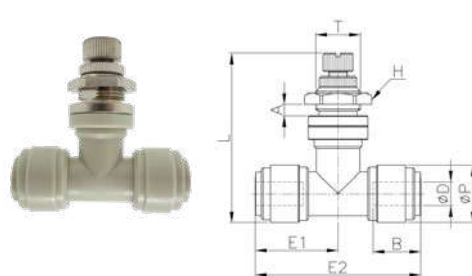

CODE	ØD	ØP	T	E1	E2	L min	L max	A	B	H	WEIGHT (G)	
HSTB1/4-1/4G	1/4	15,5	M12xP1	22,2	44,4	45,5	50,4	5,0	16,9	16	28,9	50
HSTB3/8-3/8G	3/8	20,0	M15xP1	26,1	52,1	52,7	58,4	6,0	19,8	19	54,0	25

# Flow Regulators



Elbow metric flow regulator - Regolatore di flusso a gomito metrico

## HSLU

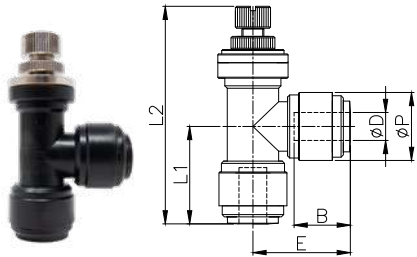

CODE	ØD	ØP	L1	L2 MIN	L2 MAX	E	B	WEIGHT (G)	
HSLU0606B	6	15,5	22,2	49,6	53,6	22,2	16,1	20,3	50
HSLU1010B	10	20,0	25,0	59,0	64,7	26,0	19,7	39,0	25

Elbow inch flow regulator - Regolatore di flusso a gomito in pollici

## HSLU

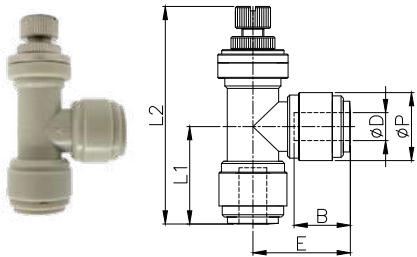

CODE	ØD	ØP	L1	L2 MIN	L2 MAX	E	B	WEIGHT (G)	
HSLU1/4-1/4G	1/4	15,5	22,2	49,6	53,6	22,2	16,9	20,3	50
HSLU3/8-3/8G	3/8	20,0	25,0	59,1	64,8	26,1	19,8	39,0	25

Metric flow regulator - Regolatore di flusso in linea metrico

## HSTU

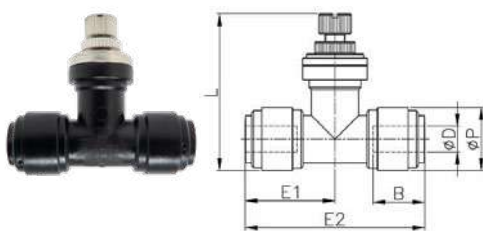

CODE	ØD	ØP	E1	E2	L min	L max	B	WEIGHT (G)	
HSTU0606B	6	15,5	22,2	44,4	37,7	42,7	16,1	20,6	50
HSTU1010B	10	20,0	26,1	52,1	44,0	49,7	19,7	39,4	25

Inch flow regulator - Regolatore di flusso in linea in pollici

## HSTU

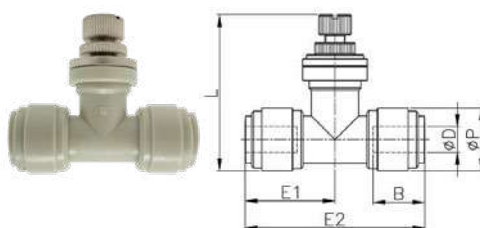

CODE	ØD	ØP	E1	E2	L min	L max	B	WEIGHT (G)	
HSTU1/4-1/4G	1/4	15,5	22,2	44,4	37,7	42,7	16,9	20,6	50
HSTU3/8-3/8G	3/8	20,0	26,1	52,1	44,0	49,7	19,8	39,4	25

## Technical Information

### MATERIALS

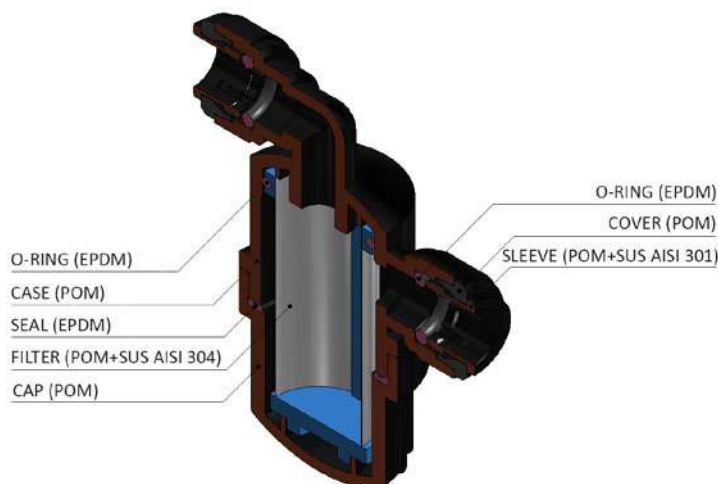

The filter of the Fluidfit range allows to prevent debris with stainless steel filter strainer by 100 mesh in water supply system.

The screw typed cap of the Fluidfit filter has an easy installation. In particular, it allows an easy substitution of the filter for the maintenance.

Il filtro della gamma Fluidfit consente di evitare la formazione di detriti con filtro in acciaio inox da 100 mesh nel sistema di alimentazione dell'acqua.

Il tappo a vite del filtro Fluidfit è di facile installazione. In particolare, consente una facile sostituzione del filtro per la manutenzione.

Please check page 4 of the present catalogue for technical data. Page 5 for working pressure and temperatures. Page 5 for instruction and page 8 for warnings and precautions.

Si rimanda a pag. 4 del presente catalogo per i dati tecnici. A pag. 5 per pressioni e temperature d'esercizio. Pag. 6 per istruzioni e pag. 8 per avvertenze e precauzioni.

### Metric sizes filter 100 mesh - Filtro metrico 100 mesh

## HBMU

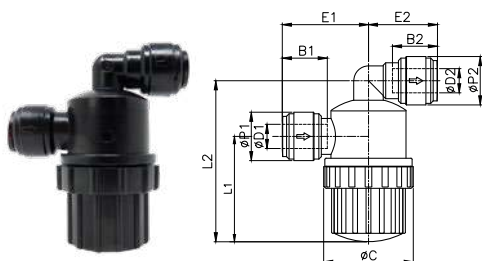

CODE	ØD1	ØD2	ØP1	ØP2	L1	L2	E1	E2	ØC	B1	B2	WEIGHT (g)	☐
HBMU0808B	8	8	20	20	43,5	66,5	35,3	28,2	37	17,5	17,5	40,9	20
HBMU1010B	10	10	20	20	43,5	66,5	35,6	28,5	37	20,1	20,1	37,6	20

HBMU: single plastic bag

### Inch sizes filter 100 mesh - Filtro in pollici 100 mesh

## HBMU

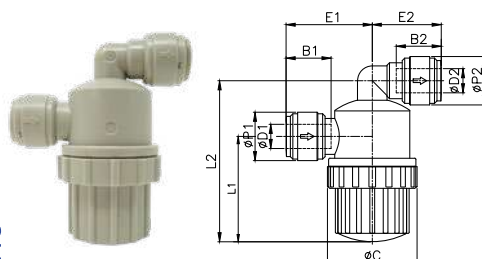

CODE	ØD1	ØD2	ØP1	ØP2	L1	L2	E1	E2	ØC	B1	B2	WEIGHT (g)	☐
HBMU3/8-3/8G	3/8	3/8	20	20	43,5	66,5	35,7	28,6	37	20,2	20,2	40,7	20

HBMU: single plastic bag

# Filters



Spare parts, stainless steel AISI 304 filter strainer by 100 mesh - Parte di ricambio, filtro 100 mesh in acciaio inox AISI 304

## HFS



CODE	
HFS0808B	20
HFS1010B	20
HFS3/8-3/8G	20

# Cartridges



Half cartridge metric & inch in acetal resin - Mezza cartuccia metrico & pollici in resina acetalica

## HCAS-P

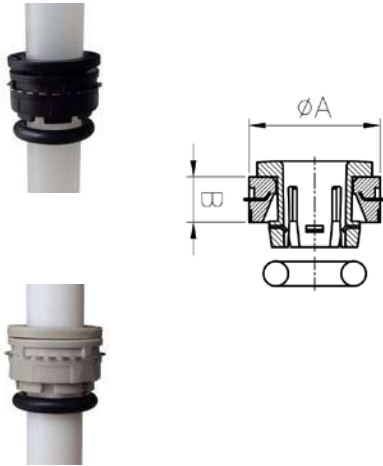

CODE	ØTUBE	ØA	B	WEIGHT (G)	☐
HCAS-P 04	4	11,85	5,0	0,8	200
HCAS-P 06	6	13,30	4,6	0,9	200
HCAS-P 08	8	13,70	5,6	1,1	100
HCAS-P 10	10	15,90	6,9	1,4	100
HCAS-P 12	12	19,60	7,9	2,6	10

CODE	ØTUBE	ØA	B	WEIGHT (G)	☐
HCAS-P 5/32	5/32	11,85	5,0	0,8	200
HCAS-P 1/4	1/4	13,30	4,6	1,0	200
HCAS-P 5/16	5/16	13,70	5,6	1,1	100
HCAS-P 3/8	3/8	15,90	6,9	1,6	100
HCAS-P 1/2	1/2	19,60	7,9	2,6	100

### BASE HOLE

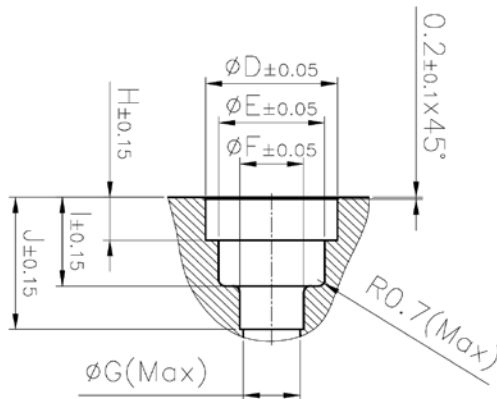

TUBE	ØD	ØE	ØF	ØG	H	I	J
4	12,00	8,30	4,15	3,30	4,90	8,90	12,80
6	13,40	10,00	6,15	5,30	4,60	9,80	14,00
8	13,80	11,95	8,15	7,40	5,50	10,15	15,00
10	16,05	14,00	10,15	9,20	6,90	11,80	18,20
12	19,75	16,55	12,15	11,20	7,75	15,90	23,90

TUBE	ØD	ØE	ØF	ØG	H	I	J
5/32	12,00	8,30	4,15	3,30	4,90	8,90	12,80
1/4	13,40	10,80	6,50	5,80	4,60	9,80	14,10
5/16	13,80	11,95	8,15	7,40	5,50	10,15	15,00
3/8	16,05	13,90	9,65	8,90	6,85	11,80	18,20
1/2	19,75	17,40	12,85	12,20	7,70	14,90	22,90

# Cartridges



Half cartridge metric & inch in brass - Mezza cartuccia metrico & pollici in ottone

## HCAS-H

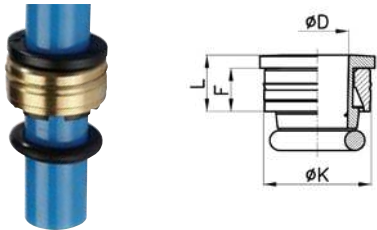

CODE	$\phi D$	$\phi K$	L	F	WEIGHT (G)	
HCAS-H 04	4	12,70	6,8	5,3	4,2	200
HCAS-H 06	6	13,60	6,6	5,0	3,9	200
HCAS-H 08	8	14,05	7,4	5,7	3,5	200
HCAS-H 10	10	16,30	8,8	7,0	5,0	100
HCAS-H 12	12	19,35	10,8	8,8	9,0	100

CODE	$\phi D$	$\phi K$	L	F	WEIGHT (G)	
HCAS-H 5/32	5/32	12,7	6,8	5,3	4,2	200
HCAS-H 1/4	1/4	13,6	6,6	5,0	3,7	200
HCAS-H 5/16	5/16	14,05	7,4	5,7	3,5	200
HCAS-H 3/8	3/8	16,3	8,8	7,0	5,5	100
HCAS-H 1/2	1/2	20,0	10,1	7,9	8,7	100

### BASE HOLE

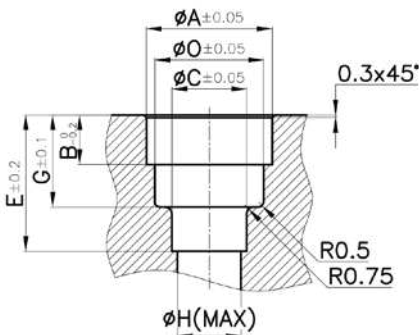

TUBE	$\phi A$	$\phi O$	$\phi C$	$\phi H \text{ max}$	B	G	E
4	12,5	8,3	4,2	3,3	4,90	8,90	12,8
6	13,4	10,0	6,2	5	4,60	9,80	14,0
8	13,82	11,95	8,2	7	5,46	10,15	15,0
10	16,05	14,0	10,2	9	6,86	11,80	18,2
12	19,1	16,55	12,2	11	8,65	15,50	23,5

TUBE	$\phi A$	$\phi O$	$\phi C$	$\phi H \text{ max}$	B	G	E
5/32	12,5	8,3	4,2	3,3	4,9	8,9	12,8
1/4	13,4	10,8	6,5	5,5	4,6	9,8	14,0
5/16	13,82	11,95	8,2	7,0	5,46	10,15	15,0
3/8	16,05	13,9	9,65	8,5	6,86	11,8	18,2
1/2	19,75	17,4	12,85	12,0	7,70	14,9	22,9

Full cartridge in brass - Cartuccia intera in ottone

## HCAS-F



CODE	$\phi D$	$\phi K$	L	F	WEIGHT (G)	
HCAS-F 04	4	10,20	12,0	10,5	3,8	200
HCAS-F 06	6	11,25	12,6	11,0	3,2	200
HCAS-F 08	8	13,25	13,2	11,5	3,9	200
HCAS-F 10	10	15,25	14,3	12,5	4,7	100
HCAS-F 12	12	17,80	16,9	14,8	7,2	100

### BASE HOLE

TUBE	$\phi A$	$\phi C$	$\phi H$	B	E
4	10,0	4,15	3,2	10,3	3,2
6	11,0	6,15	5,2	10,8	3,7
8	13,0	8,15	7,2	11,3	4,8
10	15,0	10,15	9,2	12,2	5,4
12	17,5	12,15	11,2	14,1	7,3



# Cartridges



EPDM metric & inch o-ring - O-Ring metrico & pollici EPDM

## HOR



CODE	ØD	WEIGHT (G)	
HOR04	4	0,1	1000
HOR05	5	0,11	1000
HOR06	6	0,15	1000
HOR08	8	0,21	1000
HOR10	10	0,24	1000
HOR12	12	0,32	1000
HOR15	15	0,58	1000
HOR22	22	0,98	1000

CODE	ØD	WEIGHT (G)	
HOR5/32	5/32	0,1	1000
HOR3/16	3/16	0,13	1000
HOR1/4	1/4	0,18	1000
HOR5/16	5/16	0,21	1000
HOR3/8	3/8	0,24	1000
HOR1/2	1/2	0,37	1000



## Technical Informations

### MATERIALS

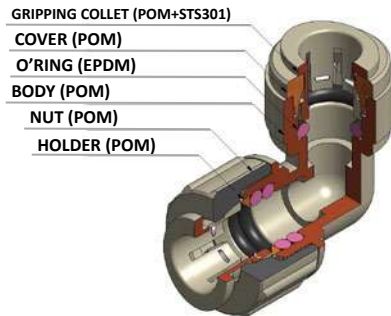

Steel Fit fittings are studied in order to satisfy the requirements related to the connection of stainless steel tubings.

I raccordi Steel Fit della gamma Fluidfit nascono per soddisfare le esigenze di connessione relative a tubi in acciaio inox.

### INSTRUCTIONS

We recommend to read and follow all the instructions, precautions and warnings contained in this catalogue before using the products in pressurized systems. Failure to follow all instructions, precautions and warnings may result in bodily harm or property damages. CDC Fluidtech Europe disclaims any responsibility in case of damages for wrong use of the products.

Si raccomanda di leggere e seguire attentamente le presenti istruzioni e di rispettare le precauzioni e gli avvertimenti contenuti nel presente documento prima dell'utilizzo dei prodotti in sistemi pressurizzati. L'inosservanza delle istruzioni, delle precauzioni e degli avvertimenti che seguono potrebbe causare danni a persone e/o cose. CDC Fluidtech Europe declina ogni tipo di responsabilità per danni derivanti dall'improprio uso dei prodotti.

### HOW TO CONNECT

For the part of the fitting to be connected to standard tubing (plastic or soft metal types), please refer to the instructions at page 10 of the present catalogue. Make sure that the tube size and the push-in system size of the fittings are the same. Cut square (90° angle) the part of the tube that has to be inserted into the fittings using the proper tube cutter. Do not use hacksaw. Make sure that the tube used is clean and does not present any scratch, crack, cut or deformity and always deburr the tube before the insertion in order not to damage the o-rings. Before inserting the tube, please remove any possible obstruction inside the fitting.

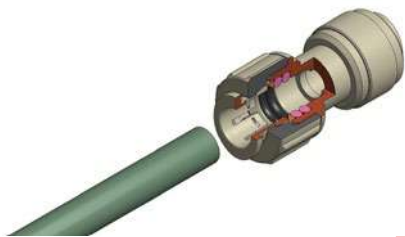

1

Per le istruzioni relative alla parte del raccordo per tubi standard (plastici o in metallo tenero) fare riferimento alle istruzioni a pagina 10 del presente catalogo. Assicurarsi che il tubo ed il sistema ad innesto rapido del raccordo siano della stessa misura. Tagliare ad angolo retto la parte di tubo che dovrà essere inserita nel raccordo mediante idoneo tagliatubi. Non utilizzare seghetti per metalli. Assicurarsi che il tubo utilizzato sia perfettamente pulito e che non presenti tagli, rotture, crepe o deformità e sbavare l'estremità al fine di evitare di danneggiare le o-ring. Prima dell'inserimento del tubo rimuovere ogni possibile ostruzione dall'interno del raccordo.

Unscrew anticlockwise the nut by hands making two turns in order to fully release the system.

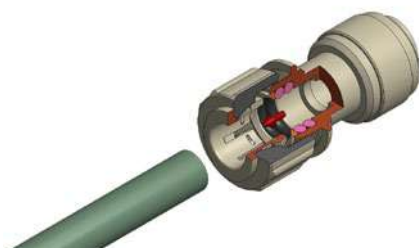

2

Svitare manualmente in senso antiorario il dado per due giri completi al fine di aprire completamente il sistema.

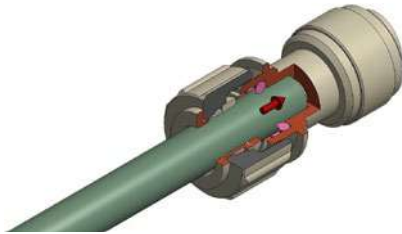

3

Make sure that the tube is correctly and fully inserted.

Inserting the tube into the fitting requires a moderate strain. The tube and the fitting should not be scratched or damaged during the insertion, otherwise there may be leaks or further wrong functions.

Please, connect the tube by hands, without using any kind of tool, whether dedicated or not.

Assicurarsi che il tubo sia correttamente e completamente inserito.

L'inserimento del tubo richiede uno sforzo moderato. Il tubo ed il raccordo non devono essere graffiati o danneggiati durante l'inserimento, in caso contrario potrebbero esserci perdite o malfunzionamenti.

Eeguire l'inserimento manualmente, senza l'utilizzo di strumenti, siano essi dedicati o improvvisati.

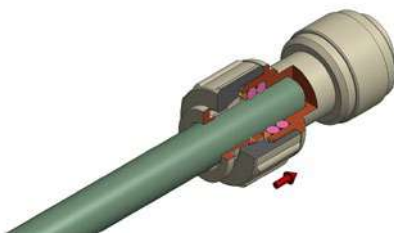

4

Keep the tube into the fitting completely inserted and screw by hands the nut

clockwise up to the fully screwed position. This will grant a perfect seal of the system and the tube will be fully gripped.

Mantenere il tubo in posizione e avvitare il dado manualmente in senso orario sino a completo avvitemento. Questa operazione garantisce una perfetta tenuta ed il completo aggraffaggio del tubo.

## HOW TO DISCONNECT

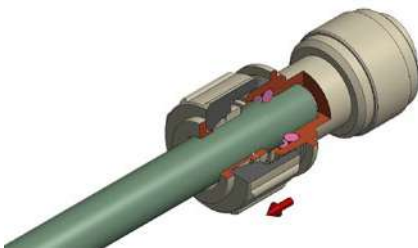

1

Unscrew anticlockwise the nut by hands making two turns in order to fully release the system.

Svitare manualmente in senso antiorario il dado per due giri completi al fine di aprire completamente il sistema.

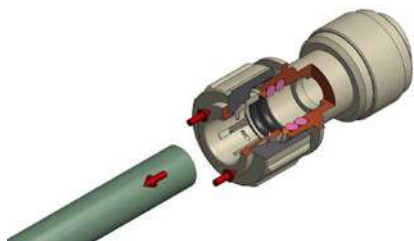

2

Push the collet in the direction of the body of the fitting and pull the tube keeping the collet pushed in order to disconnect the tube from the fitting.

Premere il colpetto di sgancio in direzione del corpo del raccordo e mantenerlo premuto mentre si sfila il tubo dal raccordo.

# Steelfit Fittings



Union connector - Intermedio diritto

## HUCP

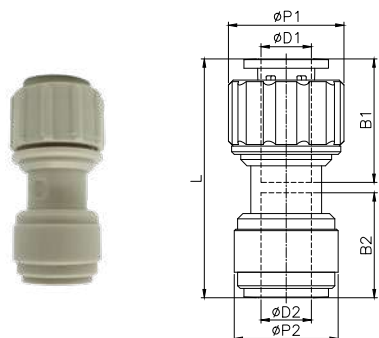

CODE	ØD1 (STEEFIT)	ØD2	ØP1	ØP2	B1	B2	L	WEIGHT (G)	
HUCP5/16-5/16G	5/16	5/16	19,3	20,0	21,1	17,5	42,9	9,8	50
HUCP3/8-3/8G	3/8	3/8	22,3	20,0	23,8	20,2	46,0	11,4	50
<b>NEW</b> HUCP1/2-1/2G	1/2	1/2	27,5	23,6	29,0	25,1	56,1	18,7	25

CODE	ØD1 (STEEFIT)	ØD2	ØP1	ØP2	B1	B2	L	WEIGHT (G)	
HUCP1/4-5/16G	1/4	5/16	19,3	20,0	19,7	17,5	41,4	9,9	50
HUCP1/4-3/8G	1/4	3/8	19,3	20,0	19,7	20,2	41,8	9,8	50
HUCP5/16-3/8G	5/16	3/8	19,3	20,0	21,1	20,0	43,3	9,5	50
HUCP5/16-1/2G	5/16	1/2	19,3	23,6	21,1	25,1	48,2	12,0	50
HUCP3/8-5/16G	3/8	5/16	22,3	20,0	23,8	17,5	45,6	11,6	50

Union elbow - Intermedio a gomito

## HULP

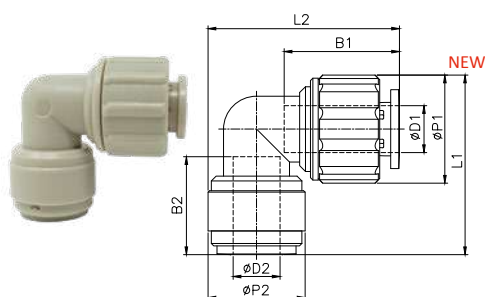

CODE	ØD1 (STEEFIT)	ØD2	ØP1	ØP2	B1	B2	L1	L2	WEIGHT (G)	
HULP5/16-5/16G	5/16	5/16	19,3	20,0	21,1	17,5	35,1	35,8	11,5	50
HULP3/8-3/8G	3/8	3/8	22,3	20,0	23,8	20,2	37,0	39,5	12,7	50
<b>NEW</b> HULP1/2-1/2G	1/2	1/2	27,5	23,6	29,0	25,1	46,4	48,3	21,2	25

CODE	ØD1 (STEEFIT)	ØD2	ØP1	ØP2	B1	B2	L1	L2	WEIGHT (G)	
HULP1/4-5/16G	1/4	5/16	19,3	20,0	19,7	17,5	35,1	35,3	11,2	50
HULP1/4-3/8G	1/4	3/8	19,3	20,0	19,7	20,2	35,5	35,3	11,0	50
HULP5/16-3/8G	5/16	3/8	19,3	20,0	21,1	20,2	35,5	35,8	10,6	50
HULP3/8-5/16G	3/8	5/16	22,3	20,0	23,8	17,5	36,6	39,5	12,8	50

Union elbow with double steel fit connections - Intermedio a gomito con doppia connessione steel fit

## HULS

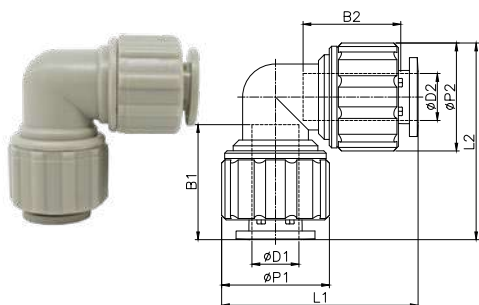

CODE	ØD1 (STEEFIT)	ØD2 (STEEFIT)	ØP1	ØP2	B1	B2	L1	L2	WEIGHT (G)	
HULS5/16-5/16G	5/16	5/16	19,3	19,3	21,0	21,0	35,4	35,4	10,2	50

# Accessories

Locking clip - Clip di bloccaggio

## HCP

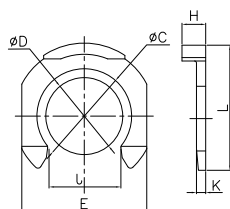

CODE	ØD	ØC	E	L	H	J	K	WEIGHT (G)	📦
HCP04-5/32	04 - 5/32	6,2	10,2	11,0	2,8	4,3	1,1	0,09	1000
HCP05-3/16	05 - 3/16	6,2	10,2	11,0	2,8	4,3	1,1	0,09	1000
HCP06-1/4	06 - 1/4	8,0	11,6	11,6	3,1	6,4	1,3	0,12	1000
HCP08-5/16	08 - 5/16	9,6	13,5	13,9	3,3	7,3	1,4	0,16	1000
HCP10-3/8	10 - 3/8	11,8	16,0	16,4	3,4	9,2	1,4	0,23	1000
HCP12-1/2	12 - 1/2	14,4	19,0	19,0	3,6	11,1	1,4	0,30	1000
HCP15	15	17,0	22,5	22,6	3,6	13,1	1,4	0,45	500
HCP22	22	24,0	30,0	29,3	3,8	19,1	1,9	0,84	300

HCP: single plastic bag 100pcs.

ØD	Grey	Black	Red	Blue
04-5/32	HCP04-5/32GR	HCP04-5/32BK	HCP04-5/32RD	HCP04-5/32BL
05-3/16	HCP05-3/16GR	HCP05-3/16BK	HCP05-3/16RD	HCP05-3/16BL
06-1/4	HCP06-1/4GR	HCP06-1/4BK	HCP06-1/4RD	HCP06-1/4BL
08-5/16	HCP08-5/16GR	HCP08-5/16BK	HCP08-5/16RD	HCP08-5/16BL
10-3/8	HCP10-3/8GR	HCP10-3/8BK	HCP10-3/8RD	HCP10-3/8BL
12-1/2	HCP12-1/2GR	HCP12-1/2BK	HCP12-1/2RD	HCP12-1/2BL
15	-	HCP15BK	HCP15RD	HCP15BL
22	-	HCP22BK	HCP22RD	HCP22BL

Spanner - Set chiavi

## HRT



CODE	ØD	WEIGHT (G)	📦
HRT	* 05 - 3/16 06 - 1/4 08 - 5/16 10 - 3/8 12 - 1/2	20	1

\* 05 - 3/16 works with 04 - 5/32

HRT: single plastic bag

HRT code includes the complete set of keys  
Il codice HRT comprende il set completo di chiavi

# Accessories

Tube cutter with tape - Tagliatubi con metro

## ETC



CODE	SIZES	PLUS	WEIGHT (G)	
ETC-20	Suitable for Fluidfit pipe	Measuring tape	47,5	1

Flow bend clip - Fascetta curva

## HBC



CODE	ØTUBE.	WEIGHT (G)	
HBC08-5/16B	8 - 5/16	4,1	10
HBC10-3/8B	10 - 3/8	11,6	10

HBC: single plastic bag

# Tubes



## Technical Information

PE tubing is made from FDA compliant.  
 Temperature: -29°C (-20°F) to +66°C (150°F)  
 Suitable for water purification, water conditioners, ice makers, misting systems and food contact applications.  
 Suitable for a wide range of temperatures and pressures.  
 Broad chemical compatibility.

Tubo PE in accordo alla FDA.  
 Temperatura: -29°C (-20°F) to +66°C (150°F)  
 Idoneo per depuratori, condizionatori ad acqua, macchine del ghiaccio, nebulizzatori e applicazioni a contatto con alimenti.  
 Idoneità per un ampio range di temperatura e pressione.  
 Estesa compatibilità chimica.

### Metric tube - tubo metrico

## PE



TUBE	Ø O.D.	Ø I.D.	Wall Thickness (mm)	Minimum bending radius at 23°C (mm)	Max Working Pressure (bar)	Working Pressure 20°C (bar)	Working Pressure 65°C (bar)	Burst pressure at 23°C (bar)	Minimum Tensile test (kgf/cm)	(mt.)
PE 0425..FF	4 ±0,08	2,5	0,75 ±0,08	25	16	15	8	30	5	200
PE 0604..FF	6 ±0,08	4	1 ±0,08	25	16	15	8	30	10	100
PE 0806..FF	8 ±0,08	6	1 ±0,08	25	12	10	6	20	15	100
PE 1007..FF	10 ±0,08	7	1,5 ±0,08	32	12	10	6	20	20	100
PE 1209..FF	12 ±0,10	9	1,5 ±0,08	63	12	10	6	20	20	100

ØD	ACS					
	Natural	Black	White	Red	Blue	Green
4x2,5	PE0425NU-FF	PE0425NE-FF	PE0425BO-FF	PE0425RO-FF	PE0425BL-FF	PE0425GN-FF
6x4	PE0604NU-FF	PE0604NE-FF	PE0604BO-FF	PE0604RO-FF	PE0604BL-FF	PE0604GN-FF
8x6	PE0806NU-FF	PE0806NE-FF	PE0806BO-FF	PE0806RO-FF	PE0806BL-FF	PE0806GN-FF
10x7	PE1007NU-FF	PE1007NE-FF	PE1007BO-FF	PE1007RO-FF	PE1007BL-FF	PE1007GN-FF
12x9	PE1209NU-FF	PE1209NE-FF	PE1209BO-FF	PE1209RO-FF	PE1209BL-FF	PE1209GN-FF

Black and blue PE tubes are certified  
 I tubi PE nero e blu sono certificati





# Tubes



Inch tube - tubo in pollici

## PE



TUBE	Ø O.D.	Ø I.D.	Wall Thickness (mm)	Minimum bending radius at 23°C (mm)	Max Working Pressure (PSI)	Working Pressure 20°C (PSI)	Working Pressure 65°C (PSI)	Burst pressure at 23°C (PSI)	Min. Tensile test (kgf/cm)	☐ (m.)
PE 3/16..FF	3/16 ±0,08	0,125" (3,18)	0,79 ±0,08	1,00" (25,4)	230	217	116	435	5	200
PE 1/4..FF	1/4 ±0,08	0,170" (4,32)	1,02 ±0,08	1,00" (25,4)	230	217	116	435	10	100
PE 5/16..FF	5/16 ±0,08	0,216" (5,49)	1,22 ±0,08	1,13" (28,7)	170	217	116	435	15	100
PE 3/8..FF	3/8 ±0,08	1/4" (6,35)	1,58 ±0,08	1,25" (31,8)	170	217	116	290	20	100
PE 1/2..FF	1/2 ±0,1	3/8" (9,53)	1,58 ±0,08	2,50" (63,5)	170	145	87	290	20	100

For size Ø5/32 tube, please use the Ø04 mm on page 55 - Per il tubo Ø5/32 si consiglia di utilizzare il tubo Ø4 a pag. 55

ØD	ACS		ACS			
	Natural	Black	White	Red	Blue	Green
3/16	PE3/16NU-FF	PE3/16NE-FF	PE3/16BO-FF	PE3/16RO-FF	PE3/16BL-FF	PE3/16GN-FF
1/4	PE1/4NU-FF	PE1/4NE-FF	PE1/4BO-FF	PE1/4RO-FF	PE1/4BL-FF	PE1/4GN-FF
5/16	PE5/16NU-FF	PE5/16NE-FF	PE5/16BO-FF	PE5/16RO-FF	PE5/16BL-FF	PE5/16GN-FF
3/8	PE3/8NU-FF	PE3/8NE-FF	PE3/8BO-FF	PE3/8RO-FF	PE3/8BL-FF	PE3/8GN-FF
1/2	PE1/2NU-FF	PE1/2NE-FF	PE1/2BO-FF	PE1/2RO-FF	PE1/2BL-FF	PE1/2GN-FF

Black and blue PE tubes are certified  
I tubi PE nero e blu sono certificati



